



TYPE 105F1-1 Integrated Flame Scanner and Temperature Analyzer



DESCRIPTION

The Fireye Paragon, type 105F1-1 flame scanner is a microprocessor based flame analysis device utilizing solid state flame detection sensors. The Paragon scanner provides high integrity sensing of multiple flame properties, including Amplitude, Flicker Frequency and Flame Learned vs. Stored Curve Fitting. Combinations of these measured properties are utilized to provide superb discrimination in a multiple burner, multi flame application as well as monitoring of flame performance characteristics such as peak flame temperature.

The Paragon scanners incorporate three internal flame relays for customer BMS interface, eliminating the need for a remote amplifier. Relay one signals the presence or absence of flame and responds to automatically set ON/OFF thresholds. Relay two signals internal faults as detected within the scanner by internal self diagnostics. Relay three signals flame temperature is above or below adjustable user designated values. The flame and fault relay must be connected to the BMS to provide adequate safety monitoring of the flame presence. The temperature relay can be used for alarming or signaling or can be connected to the BMS for remote monitoring.

For accurate detection of flame presence, Paragon scanners monitor the amplitude of the modulation (the flame "flicker") that occurs within the targeted flame, over a wide frequency. During the scanner setup procedure, the amplitude of the target flame over time is automatically stored by the flame scanner, together with algorithms for optimum ON/OFF criteria. Fast Fourier Transform algorithms within the product determine and monitor the flicker frequencies of the flame and constantly compare stored and real time information. The combination of these multiple tests provides the perfect balance between reliable availability and operational safety.

Paragon scanners incorporate full self diagnostics and electronic self checking and are available in multiple models differentiated by connection style, levels of hazardous area certifications and agency approvals. Refer to Table 1 for an overview of model numbers and specifications

APPLICATION

Fireye Paragon type 105F1-1 flame scanners are used to detect emissions from fossil fuel flames. These can be gaseous fuel, light petroleum distillates, diesel fuels, heavy fuel oils and a variety of coals. They are suited for application to multiple burner furnaces in utilities and pulp and paper plants, industrial application such as petrochemical, refinery and chemical production, through to industrial boilers. Flame temperature measurement can be used to monitor and report on many applications including specialized burners used in applications such as Low NOx, Incineration and sulfur recovery.

OPERATOR & SYSTEM INTERFACE

Local interface to the Paragon scanner is via a pushbutton keypad with information LED's. These provide continuous indication of flame signal, flame temperature, flame relay status, scanner status as well as selected mode of operation. The "view a flame" is a fiber optic lens that reflects light from the front view of the scanner to the operator interface. Simplified keystroke routines are used for setup and this can be completed in seconds. For remote interface, outputs are provided for flame switch, fault relay, temperature relay, 4 to 20mA flame strength and 4 to 20mA flame temperature range. RS485 connections are provided for remote software communications. Hard wired file select connections allow switching between up to four memory files for multiple independent scanner set ups.

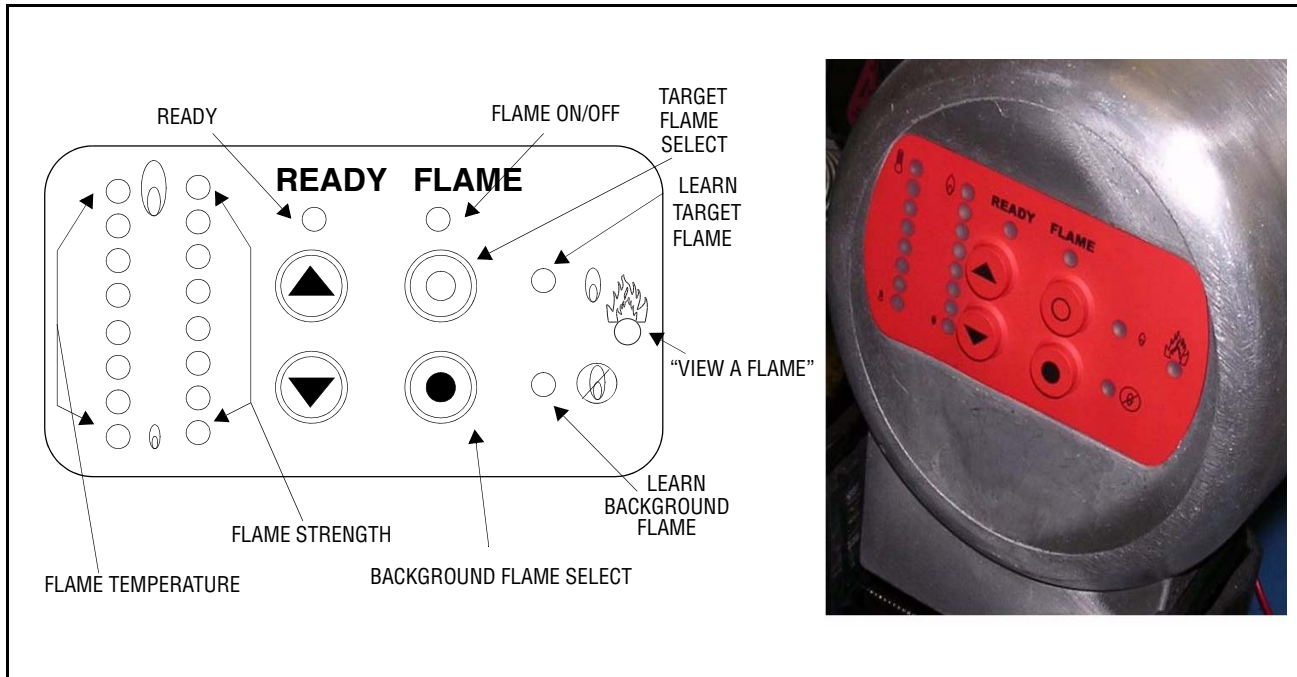

FIGURE 1. DIMENSIONS, SCANNER AND MOUNTING FLANGE

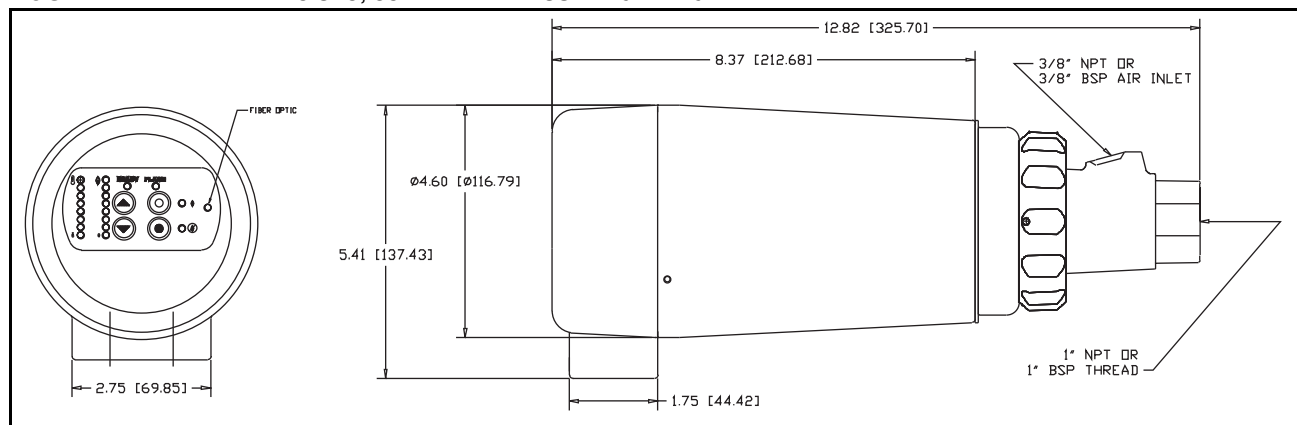
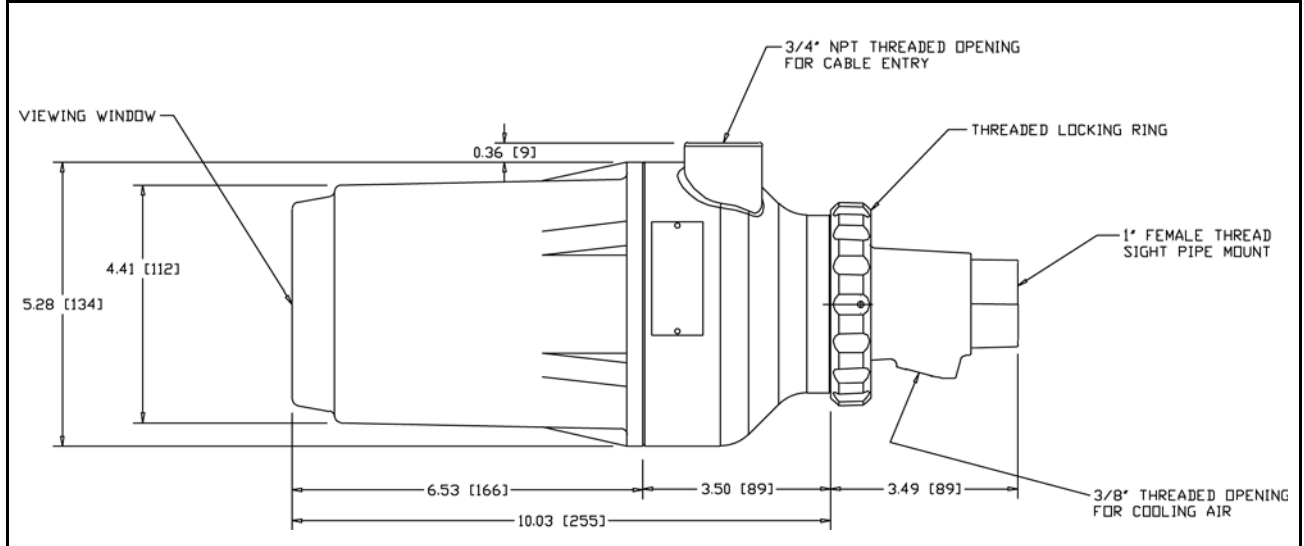
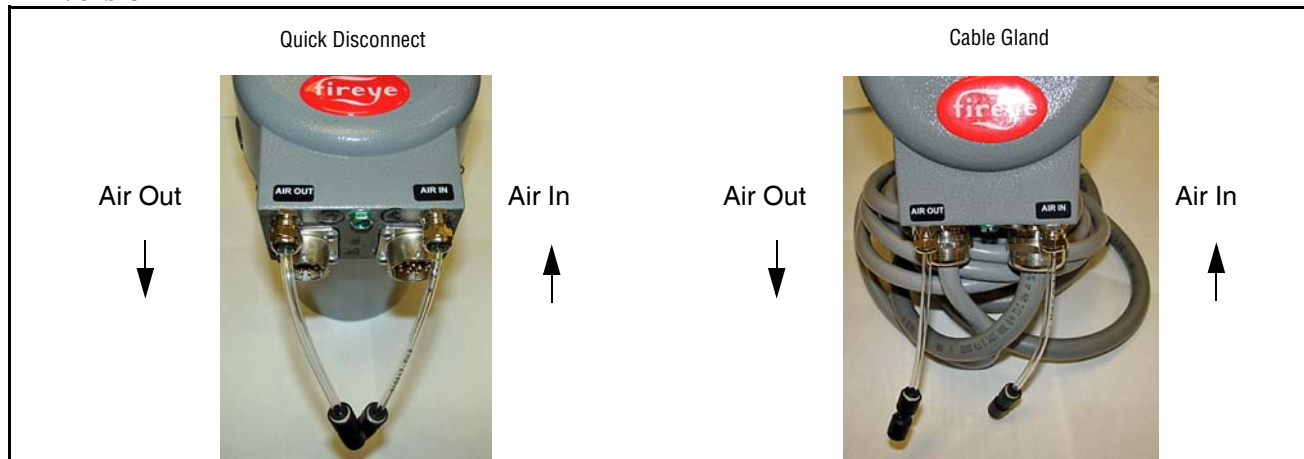

FIGURE 2. DIMENSIONS, SCANNER AND MOUNTING FLANGE CEX VERSION*Note*



Note: The accessories used for cable entries shall be certified according to EN 60079-0 and EN 60079-1 standard and must guarantee a degree of protection IP66 minimum.

ET Version





SCANNER BASE PART NUMBERS AND APPROVALS

Table 1: Paragon Scanner Base Versions and Accessories

SCANNER MODEL OR ACCESSORY	MOUNTING THREADS		AGENCY APPROVALS					DESCRIPTION
	Sight Pipe Connection	Cooling Air Connection	FM*	UL C/US	DIN CERTCO	DVG W	CE	Integrated Flame Scanner 24 VDC
105F1-1			X	X	X	X	X	Plug and socket electrical connection
105F1-1CG			X	X	X	X	X	10 ft cable gland electrical connection
105F1-1CEX					X	X	X	IP66 ATEX EExd IIC T6
105F1-1ET								Extended temperature version plug and socket electrical connection
105F1-1CGET								Extended temperature version 10 ft cable gland electrical connection
129-182-1	1" NPT	3/8" NPT	Mounting Flange Assembly Kit					
129-182-2	1" BSP	3/8" BSP						

*Class I, Division 2, Groups A, B, C and D, Class II, III, Division 2, Groups F and G, NEMA 4X, IP66

Note: The housing into which the Model CEX Paragon electronics are installed has been approved by ATEX for use in EExd IIC T6 hazardous areas.

Note: The flame failure response time (FFRT) between 1 to 4 seconds of Paragon scanners is determined by programming the scanner. See page 16 "programming the Paragon flame failure response time" for full details.

Table 2:

PARAGON SCANNER EXTENDED CABLE GLAND VERSIONS AND ACCESSORIES	
Part Number	Description
105F1-1CG-020	Paragon cable gland scanner with 20 feet of cable
105F1-1CG-030	Paragon cable gland scanner with 30 feet of cable
105F1-1CG-040	Paragon cable gland scanner with 40 feet of cable
105F1-1CG-050	Paragon cable gland scanner with 50 feet of cable
105F1-1CG-060	Paragon cable gland scanner with 60 feet of cable
105F1-1CG-070	Paragon cable gland scanner with 70 feet of cable
105F1-1CG-080	Paragon cable gland scanner with 80 feet of cable
105F1-1CG-090	Paragon cable gland scanner with 90 feet of cable
105F1-1CG-100	Paragon cable gland scanner with 100 feet of cable
105F1-1CGET-020	Paragon extended temperature scanner with cable gland and 20 feet of cable
105F1-1CGET-030	Paragon extended temperature scanner with cable gland and 30 feet of cable
105F1-1CGET-040	Paragon extended temperature scanner with cable gland and 40 feet of cable
105F1-1CGET-050	Paragon extended temperature scanner with cable gland and 50 feet of cable
105F1-1CGET-060	Paragon extended temperature scanner with cable gland and 60 feet of cable
105F1-1CGET-070	Paragon extended temperature scanner with cable gland and 70 feet of cable
105F1-1CGET-080	Paragon extended temperature scanner with cable gland and 80 feet of cable
105F1-1CGET-090	Paragon extended temperature scanner with cable gland and 90 feet of cable
105F1-1CGET-100	Paragon extended temperature scanner with cable gland and 100 feet of cable
59-5356-10TB	60-2862 termination/junction box with 10 feet of cable for use with Paragon scanner
59-5356-20TB	60-2862 termination/junction box with 20 feet of cable for use with Paragon scanner
59-5356-30TB	60-2862 termination/junction box with 30 feet of cable for use with Paragon scanner
59-5356-40TB	60-2862 termination/junction box with 40 feet of cable for use with Paragon scanner
59-5356-50TB	60-2862 termination/junction box with 50 feet of cable for use with Paragon scanner
60-2862	Paragon termination/ junction box for local cable termination



PREFABRICATED CABLES FOR PARAGON QUICK DISCONNECT FLAME SCANNERS

Note: One of each 59-535C and 59-536C are required to connect the scanner

Part Number	Description
59-535C-010	Twelve conductor prefabricated cable complete with terminated plug connectors, 10 feet long
59-535C-020	Twelve conductor prefabricated cable complete with terminated plug connectors, 20 feet long
59-535C-030	Twelve conductor prefabricated cable complete with terminated plug connectors, 30 feet long
59-535C-040	Twelve conductor prefabricated cable complete with terminated plug connectors, 40 feet long
59-535C-050	Twelve conductor prefabricated cable complete with terminated plug connectors, 50 feet long
59-535C-060	Twelve conductor prefabricated cable complete with terminated plug connectors, 60 feet long
59-535C-070	Twelve conductor prefabricated cable complete with terminated plug connectors, 70 feet long
59-535C-080	Twelve conductor prefabricated cable complete with terminated plug connectors, 80 feet long
59-535C-090	Twelve conductor prefabricated cable complete with terminated plug connectors, 90 feet long
59-535C-100	Twelve conductor prefabricated cable complete with terminated plug connectors, 100 feet long
59-535C-120	Twelve conductor prefabricated cable complete with terminated plug connectors, 120 feet long
59-535C-140	Twelve conductor prefabricated cable complete with terminated plug connectors, 140 feet long
59-535C-160	Twelve conductor prefabricated cable complete with terminated plug connectors, 160 feet long
59-535C-180	Twelve conductor prefabricated cable complete with terminated plug connectors, 180 feet long
59-535C-200	Twelve conductor prefabricated cable complete with terminated plug connectors, 200 feet long
59-535C-250	Twelve conductor prefabricated cable complete with terminated plug connectors, 250 feet long
59-535C-300	Twelve conductor prefabricated cable complete with terminated plug connectors, 300 feet long
59-536C-010	Eight conductor prefabricated cable complete with terminated plug connectors, 10 feet long
59-536C-020	Eight conductor prefabricated cable complete with terminated plug connectors, 20 feet long
59-536C-030	Eight conductor prefabricated cable complete with terminated plug connectors, 30 feet long
59-536C-040	Eight conductor prefabricated cable complete with terminated plug connectors, 40 feet long
59-536C-050	Eight conductor prefabricated cable complete with terminated plug connectors, 50 feet long
59-536C-060	Eight conductor prefabricated cable complete with terminated plug connectors, 60 feet long
59-536C-070	Eight conductor prefabricated cable complete with terminated plug connectors, 70 feet long
59-536C-080	Eight conductor prefabricated cable complete with terminated plug connectors, 80 feet long
59-536C-090	Eight conductor prefabricated cable complete with terminated plug connectors, 90 feet long
59-536C-100	Eight conductor prefabricated cable complete with terminated plug connectors, 100 feet long
59-536C-120	Eight conductor prefabricated cable complete with terminated plug connectors, 120 feet long
59-536C-140	Eight conductor prefabricated cable complete with terminated plug connectors, 140 feet long
59-536C-160	Eight conductor prefabricated cable complete with terminated plug connectors, 160 feet long
59-536C-180	Eight conductor prefabricated cable complete with terminated plug connectors, 180 feet long
59-536C-200	Eight conductor prefabricated cable complete with terminated plug connectors, 200 feet long
59-536C-250	Eight conductor prefabricated cable complete with terminated plug connectors, 250 feet long
59-536C-300	Eight conductor prefabricated cable complete with terminated plug connectors, 300 feet long



24 Volt DC Power Supplies

Fireeye offers two DIN rail mounted 24 vdc power supplies for use with the Paragon Integrated flame scanner. Model 60-2685-2 (2 amp) can power up to 10 Paragon scanners, model 60-2685-4 (4 amp) can power up to 20 Paragon scanners (see note 1). Refer to bulletin CU-100 for details.

PART NUMBER	DESCRIPTION	NOTES
60-2685-2	24 VDC Switching Power Supply, 50W, 100-230 vac 50/60 Hz. input, 2.1 A output at 24 vdc. Powers up to 8 scanners. Dimensions: 3.2"(82mm) high x 3.5" (90mm) wide x 3.6"(91mm) deep	1, 2
60-2685-4	24 VDC Switching Power Supply, 100W, 120 / 230 vac 50/60 Hz. input, 4.2 A output at 24 vdc. Powers up to 16 scanners. Dimensions: 3.2"(82mm) high x 5.7" (145mm) wide x 3.6"(91mm) deep	1, 2
60-2539-12	DIN mounting rail, 12" (305mm) long	2
60-2539-24	DIN mounting rail, 24" (610mm) long	2
60-2539-36	DIN mounting rail, 36" (914mm) long	2

- Notes:**
1. Rated output is when power supply is vertically mounted, and with an ambient temperature of 122°F (50°C) maximum. When supply is mounted vertically, at 140°F (60°C) the output is de-rated 25%.
 2. When mounted in a row, allow at least 0.79" (20mm) between adjacent power supplies.

SPECIFICATIONS

MECHANICAL:

Housing Material: Cast aluminum with gray polyester powder coat finish

Housing Weight: 5.5 lbs (2.5kg), non-“CG” models
 5.5 lbs (2.5kg), ET non-“CG” models
 6.9 lbs. (3.1kg) “CG” models
 7.5 lbs. (3.4kg) “CEX” models
 8.6 lbs. (3.9kg) ET “CG” models

Environmental: NEMA 4X, IP66, Class I Division 2, Groups A, B, C and D, Class II Division 2, Groups F and G (refer to agency approvals table). CEX versions are ATEX EExd IIC T6 and IP66 rated

Mounting: Uses mounting flange kits ordered separately (see below).

Mounting Flange Kit: P/N 129-182-1 1" NPT female pipe mount flange kit, includes gasket, flange adapter, mounting snout and locking ring. See Fig. 1.

P/N 129-182-2 1" BSP female pipe mount flange kit, includes gasket, flange adapter, mounting snout and locking ring. See Fig. 1.

Mounting Flange

Shipping Weight: 0.62lbs. (0.28kg)

Cooling / Purge Air Requirements:

Source: Clean, dry, cool

Volume: 4 SCFM (113 l/min) at 3/8" threaded mounting flange, or 1 inch “Y” fitting, mounted on scanner sight pipe. Temperature near the upper limit of the scanner operating range and/or use with dirty/dusty fuels may require up to 15 SCFM (425 l/min).

Pressure: Adequate to overcome furnace or windbox pressure

Cooling Air Requirements for “ET” Models:

Pressure: Normal operating 40 to 45 psi, 60 psi Max.

Inlet air temp to be from +10°C to +26°C (Warning: if inlet air is greater than +26°C then the scanner temperature rating is de-rated).

Inlet and exhaust air to be attached to the scanner by means of 1/4" OD tubing with no less than a 1/8" inside diameter.:

Temperature Rating: -40°F to + 150°F (-40°C to +65°C)

+50°F to + 185°F (+10°C to +85°C) for extended temperature “ET” versions

Humidity: 0% to 95% relative humidity, non-condensing



ELECTRICAL:

Input Power:	24 Vdc, +20%, -25% supply current: 200mA
Electrical Connection:	12-pin and one 8-pin quarter-turn quick-disconnect socket per scanner. “CG” models have cable glands and 10 ft (3m) of captive cables “CEX” models have 3/4” threaded opening and internal terminal blocks
Relay Output	Flame Safety Relay (Com, N.O., N.C.), Fault Safety Relay (N.O.), Flame Temperature Relay (N.O.)
Contact Rating:	Minimum: 10 mA @ 5 Vdc. Maximum: 1 A @ 30 Vdc 1 A @ 50 Vac (CE quick connect models) 1 A @ 230 Vac (FM & UL C/US models and all “CG” models)
Analog Output:	Two 4 to 20mA analog outputs one for Flame Signal, one for flame temperature. Optically isolated 4 to 20mA DC current referenced to 24 Vdc common, maximum connected load: 750 ohms. Fireye recommends the 60-2685-X 24 Vdc power supply for best performance and for a SELV rating of the 4-20mA analog output leads.
Analog Input:	One 4 to 20mA analog input. (For future use).
Status Indication:	LED display of measured flame signal and peak temperature, flame relay ready, flame learn select and fault codes. Multiple LED indication for flame signal strength, flame relay, ready, target, background select and fault codes.
Operator Interface:	Four (4) pushbutton style keys
Cable Specification:	P/N 59-536 (8 conductors), 59-535 (12 conductors): Lead free, rugged, multi-conductor control and signal cable for industrial applications. Finely stranded tinned copper conductors. Multiple approvals, UL type PLTC, UL CMG, UL Oil Res. 1, CMG and CE. PLTC with open wiring approval allows for use in overhead trays eliminating the need for conduit. UV resistant and is approved for direct burial and meets Class 1, Div. 2 requirements.

INSTALLATION NOTES

Paragon flame scanners determine the presence or absence of flame by monitoring the amplitude of the flame across a wide flicker frequency spectrum. The scanner should initially be mounted so that the primary combustion zone is within the scanner’s line of sight.

The location and sighting instructions listed in the following sections are rough guidelines for the location of the scanner. The scanner provides feedback via LEDs and the 4-20ma output to assist in the adjustment and proper alignment of the flame scanner. Refer to the set-up procedures described in this bulletin.

Note: An acceptable scanner location must ensure the following:

Reliable main flame and/or ignitor flame detection at all air flow and furnace loads (ranges of fuel firing).

Rejection of the ignitor flame if too short or in the wrong position to ignite the main flame reliably, thus prohibiting the delivery of fuel to the burner.

INSTALLATION PROCEDURE



WARNING: Protective filtered lenses should be worn when viewing flame; infrared and ultraviolet energy from the flame can be damaging to the eyes.

1. The best results are obtained when the scanner is aimed so that the scanner’s line of sight intersects the burner center at a slight angle (e.g. 5 degrees) and sees a maximum of the primary combustion zone, as shown in Figure 3. If only one scanner is used per burner, the line of sight should also intersect the igniting flame.
2. For installations where separate scanners are used to monitor main and ignitor flames, the main flame scanner should be sighted so it does not detect the ignitor flame.

3. The scanner should have an unrestricted view of flame as far as possible. Physical obstructions such as air register blades, interfering vanes, or other hardware should be cut away or notched so they do not fall within the scanner's line of sight.

*Note: Always check with the burner manufacturer **before** you trim the register blades.*

FIGURE 3.

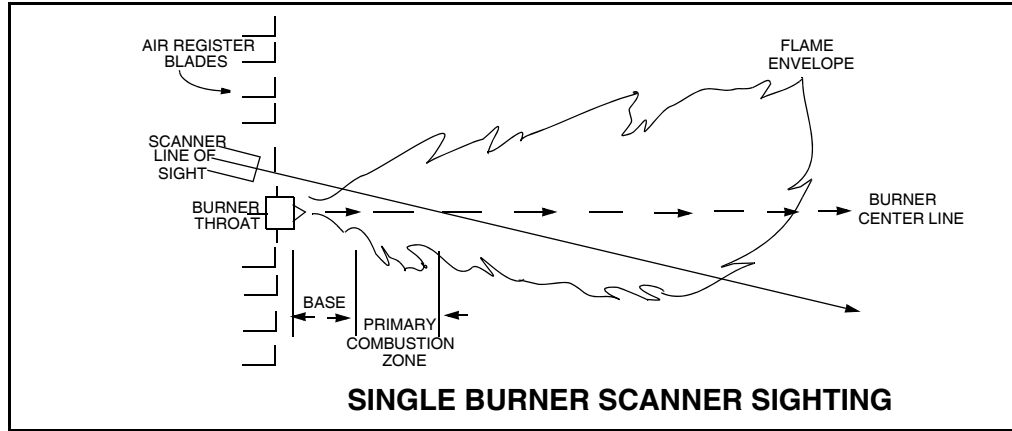

4. AN ACCEPTABLE SCANNER LOCATION MUST ENSURE THE FOLLOWING:
 - Reliable pilot flame detection.
 - Reliable main flame detection.
 - Rejection of pilot flame too short or in the wrong position to ignite the main flame reliably, thus prohibiting main fuel admission.

Note: Reliable signals must be obtained at all air flows and furnace loads (ranges of fuel firing).

FIGURE 4.

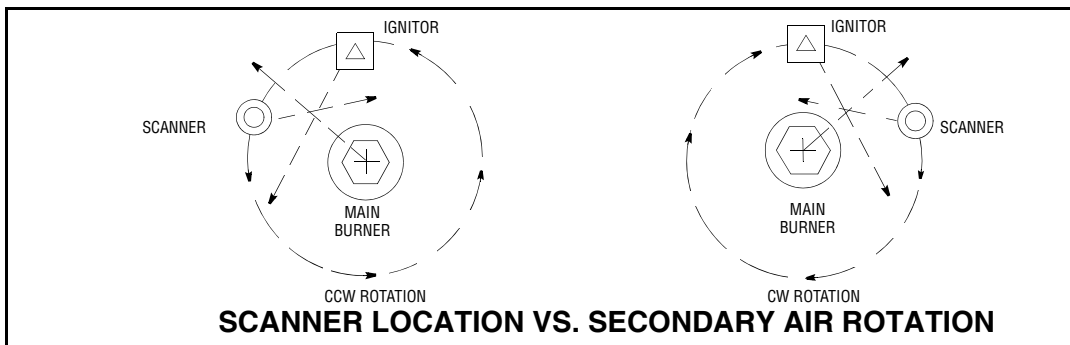

5. If combustion air enters the furnace with a rotational movement of sufficient velocity to deflect pilot flame in direction of rotation, position the scanner 0 to 30 degrees downstream of the pilot burner and close to the periphery of the throat where the ultraviolet radiation is at a maximum. (See Figures 3 and 4).

Having determined an appropriate location for the sight tube, cut a clearance hole for a 2 inch pipe through the burner plate. If register vanes interfere with the desired line of sight, the interfering vane(s) should be trimmed to assure an unobstructed viewing path at all firing levels, see example shown below.

*Note: Always check with the burner manufacturer **before** you trim register vanes.*

FLAME MUST COMPLETELY COVER SIGHT OPENING



6. The preferred method for mounting surface mounted scanners requires the use of a swivel mount, P/N 60-1664-3 (NPT), shown in Figure 4. Center the swivel mount over the two inch hole in the burner plate and secure using three hexed cap screws (not provided). Install the sight pipe on the swivel mount. If a swivel is not used, insert the end of the sight pipe into the hole, align the hole to the desired viewing angle and tack weld (welding must be adequate to temporarily support the weight of the installed scanner). The sight pipe should be arranged to slant downward so that dirt and dust will not collect inside.
7. When a satisfactory sighting has been confirmed by operational testing, secure the swivel mount's ball position in place by tightening the three hex head cap screws located on the swivel mount ring.
8. For ease of use, the scanner should be installed on the sight pipe so the LED display can easily be read.

Note: Operation of the LED display is independent of position.

9. The scanner lens must be kept free of contaminants (oil, ash, soot, dirt) and the scanner housing temperature must not exceed its maximum rating of 150° F (65° C). Excessive temperatures will shorten scanner life. Both requirements will be satisfied by a continuous injection of purge air at either the 3/8" housing inlet or the 1" "Y" connection ahead of the swivel mount as shown in Figure 4.

The scanner mounting may be made with provision for purge air through only the 3/8" opening or for purge air through either the 3/8" opening or the 1" "Y" connection. In the latter arrangements, normally only one of the two connections is provided with purge air and the other connection is plugged. When a sealing coupling is used, the 1" "Y" connection is used for the purge air and the 3/8" opening is plugged.

It is good practice to use the sealing coupling (P/N 60-1199-1 with NPT threads) on all installations to insure against unwanted furnace pressures from damaging the scanner lens.

Under normal conditions, with clean burning fuels and moderate ambient temperature conditions, purge air flow of approximately 4 SCFM (133 l/min) is generally adequate. Up to 15 SCFM (425 l/min) may be required for fuels that produce high levels of ash or soot, or for hot environments to maintain the scanner's internal temperature within specification.



CAUTION: To ensure safe and reliable detection it is the responsibility of the commissioning engineer to carry out flame failure testing after programming the scanner.

Ensure that the scanner correctly detects the target flame (Flame On condition) and recognizes the target flame off (Flame Off condition).



WARNING: When working with the Paragon ET product in its normal use, the product could see elevated temperatures up to 85 degrees celsius which could be harmful to the touch. Extreme caution is required when working with this product.

FIGURE 5.

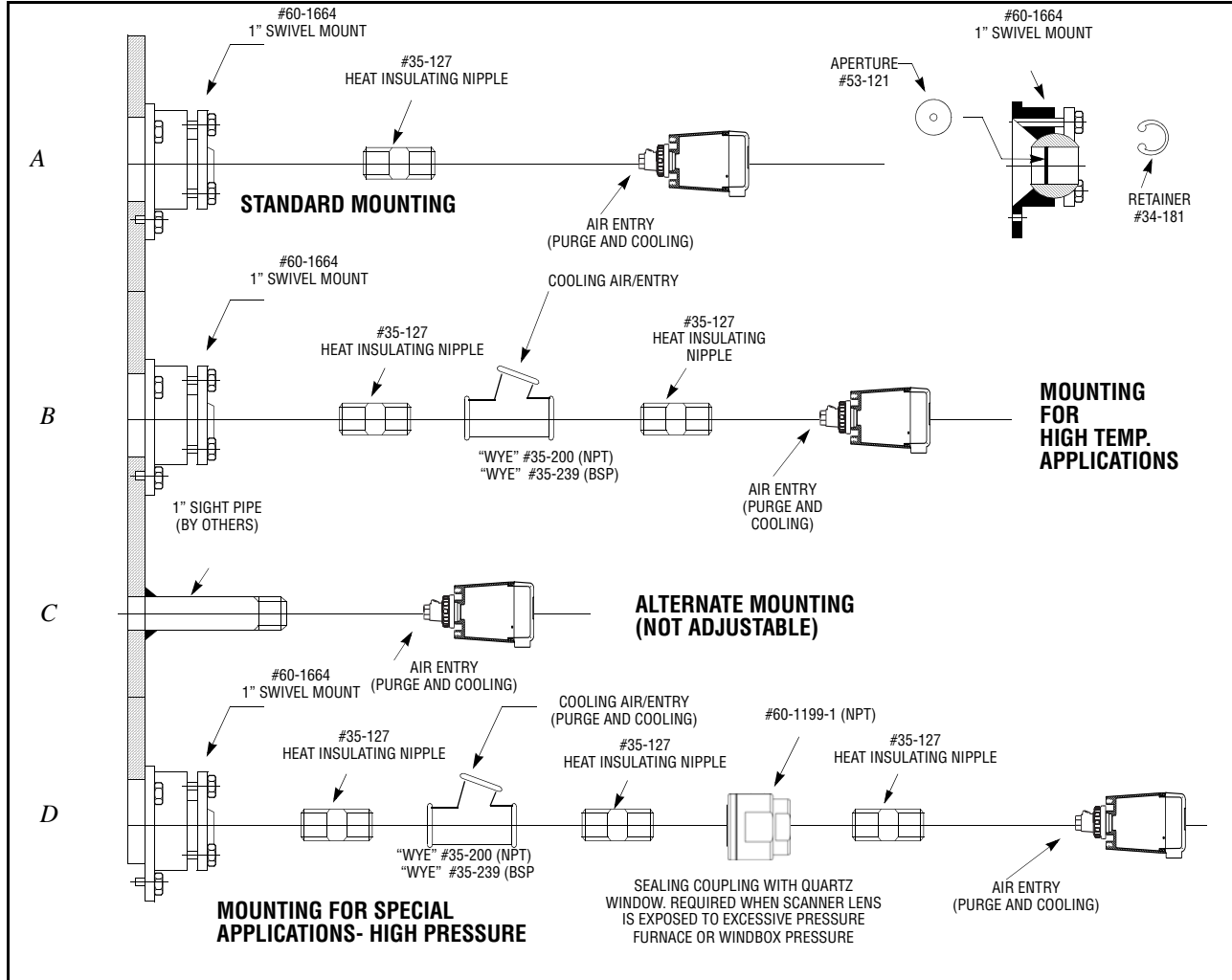

SCANNER WIRING

The cable used on the 105F1-1, -1GG, -1ET, -1CGET is not to be flexed at temperatures lower than -25°C. .



CAUTION: The Paragon flame scanner requires 24 Vdc power for operation. Connection to a 24 Vac or 120 Vac power source will damage the scanner. Refer to wiring diagrams. External 2.0 Amp fuses are required to protect Flame Relay and Fault Relay contacts. All wiring to the scanner should be rated at 90°C. For runs less than 1000 feet, the use of Fireye Scanner Cable, P/N 59-535, (12 wire), P/N 59-536, (8 wire) is recommended. For runs in excess of 1000 feet, consult the factory.



CAUTION: The Paragon flame scanner 4-20mA analog output is SELV rated only when the Paragon is powered by an SELV rated 24 VDC power supply. The recommended Fireye 60-2685 power supply is SELV rated.

FIGURE 6. WIRING DIAGRAM

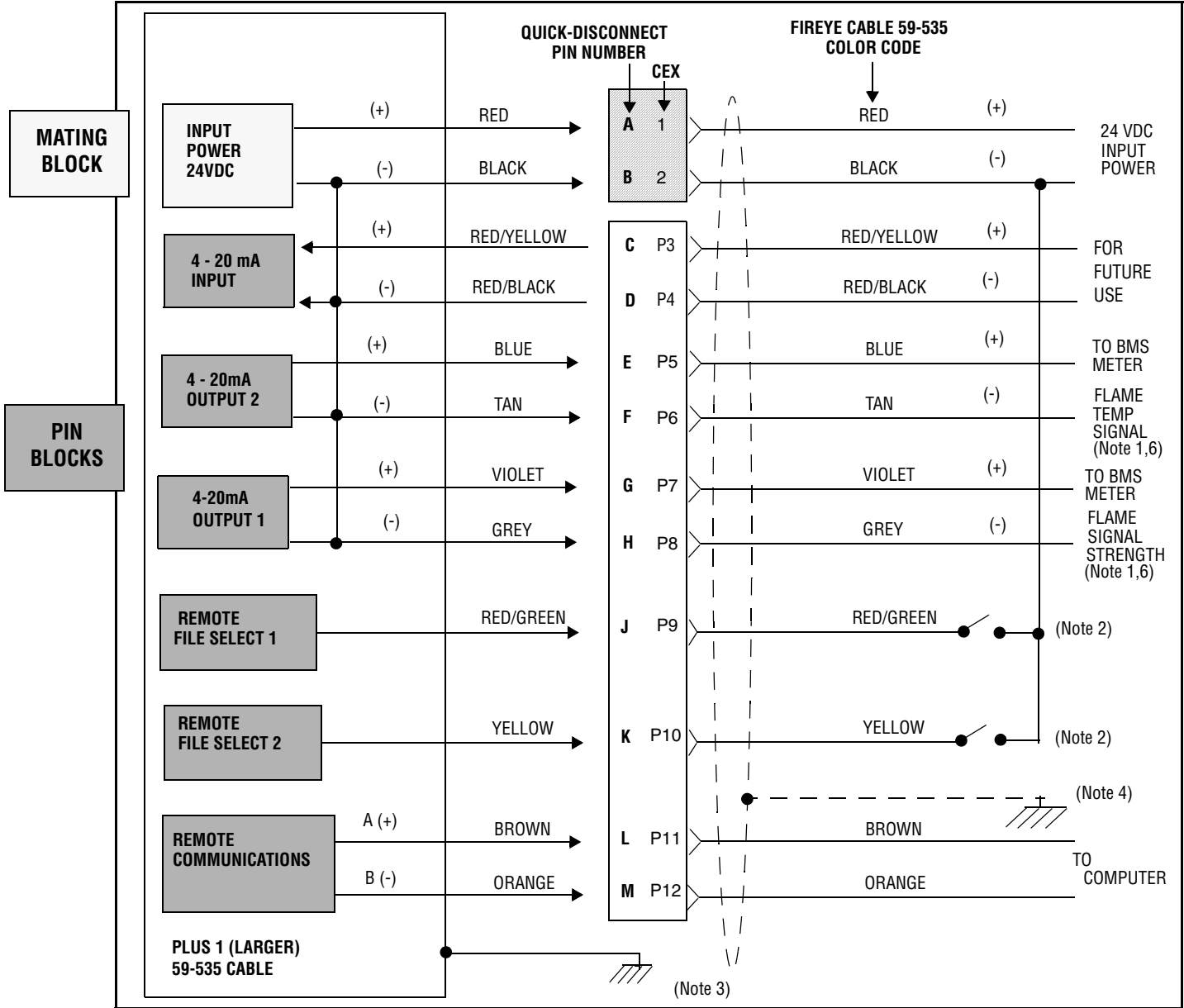

Notes:

1. BMS = Burner Management System (by others).
2. Remote File Select uses external switches (not furnished) to select up to four individual operating files or internal memory files, when connected to 24Vdc (-) supply, as shown above. Selection is based on open/open (File 1) closed/open (File 2) open/closed (File 3) closed/closed (File 4).
3. **A functional ground screw is provided on the scanner end plate. An external ground wire can be installed to comply to local codes.**

Note: This should be connected at the power source if possible.

There are no internal customer replaceable parts.
4. Connect cable shield to earth ground at power source.
5. The following peripherals must be SELV/PELV by an approval according to DIN EN 60950 or and external isolator must be used to provide an SELV system:
 - 24V power supply (Fireeye power supply #60-2685-2 is SELV)
 - RS485
 - 4-20mA wiring
 - Remote file select monitoring
6. Once the target flame has been learned/stored at the lowest acceptable setting

for flame on condition (not less than 3 to 4 LED's on the scanner), the 4 to 20mA output is automatically ranged to give 4mA at that learned setting (4 LED's) up to 20mA at maximum (8 LEDs). Below 4 LED's the signal will remain at minimum or 4mA.

FIGURE 7.

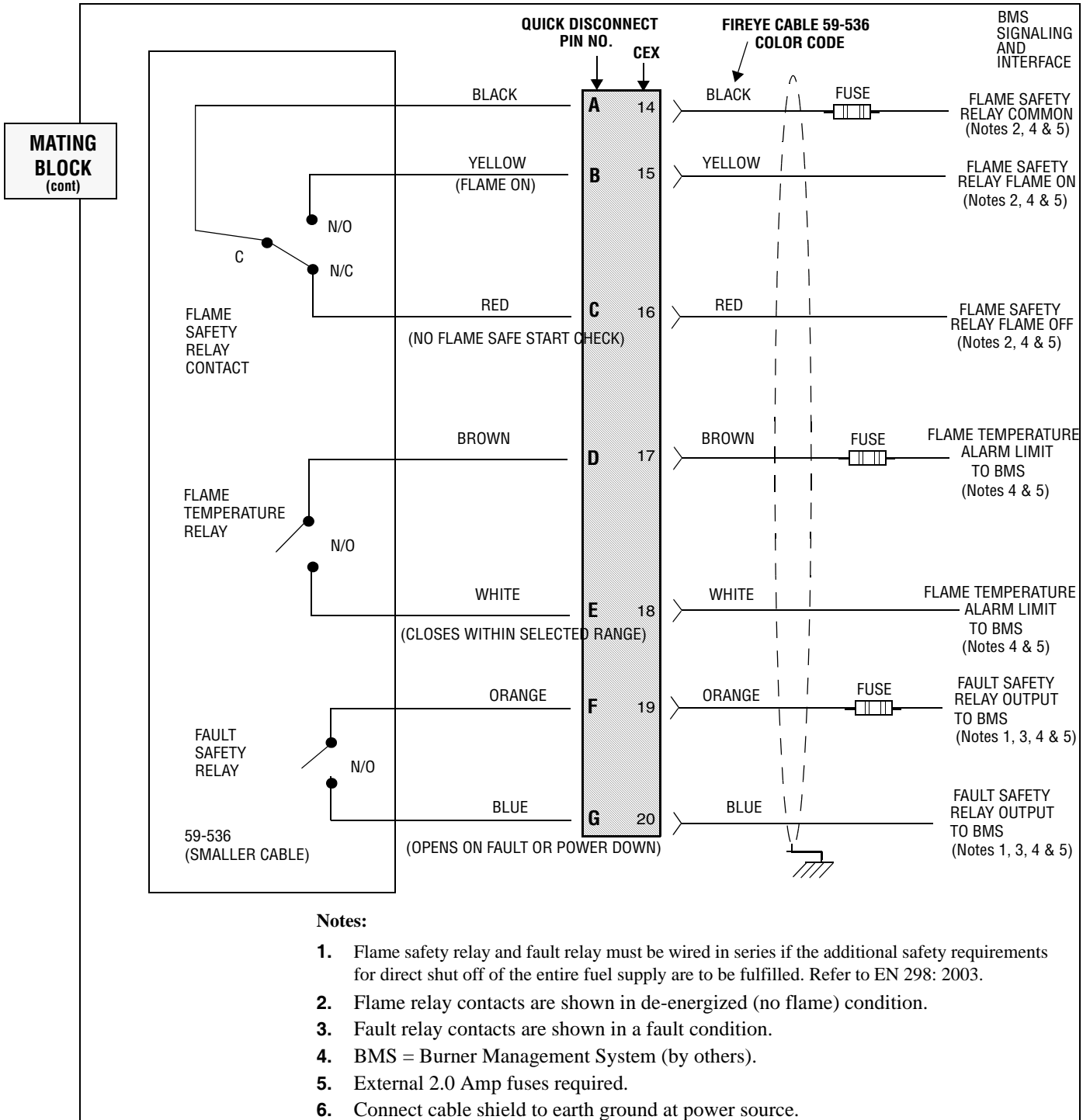

Cable	Color	Pa ragon Function	Connecto r	Wiring Harness	Wire cable to
59-535 Cable	Red	Power (+) 24VDC	A	1	To Control Room (Burner Management System)
	Black	Power (-)24VDC	B	2	
	Red/Yellow	4-20ma Input (+)	C	3	
	Red/Black (For Future Use)	4-20ma Input (-)	D	4	
	Blue	4-20ma Output 2 (+)	E	5	
	Tan	4-20ma Output 2 (-)	F	6	
	Violet	4-20ma Output 1 (+)	G	7	
	Gray	4-20ma Output 1 (-)	H	8	
	Red/Green	File Select 1	J	9	
	Yellow	File Select 2	K	10	
	Brown	RS-485 COMM A	L	11	
	Orange	RS-485 COMM B	M	12	
59-536 Cable	Black	Flame Relay (COM)	A	14	
	Yellow	Flame Relay (N.O)	B	15	
	Red	Flame Relay (N.C)	C	16	
	Brown	Flame Temp Set Point (COM)	D	17	
	White	Flame Temp Set Point (N.O)	E	18	
	Orange	Fault (COM)	F	19	
	Blue	Fault (N.O)	G	20	



WARNING: Connect the flame relay and fault relay contacts in series for maximum safety operation.

Top

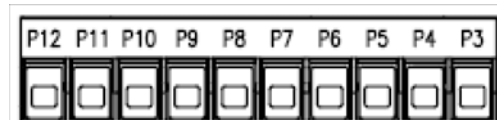
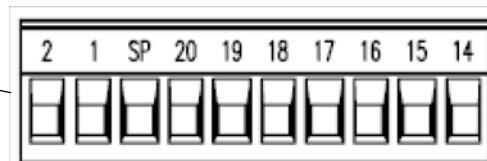

Connector packaged separately

FLAME TEMPERATURE

The Paragon Scanner measures the average flame temperature within the field of view of the scanner. This enables the user to assess the temperature at the time of commissioning and monitor variations in real time. Flame temperature can be used as a diagnostic indication of the performance of the combustion as illustrated in the graph below.

FIGURE 8.

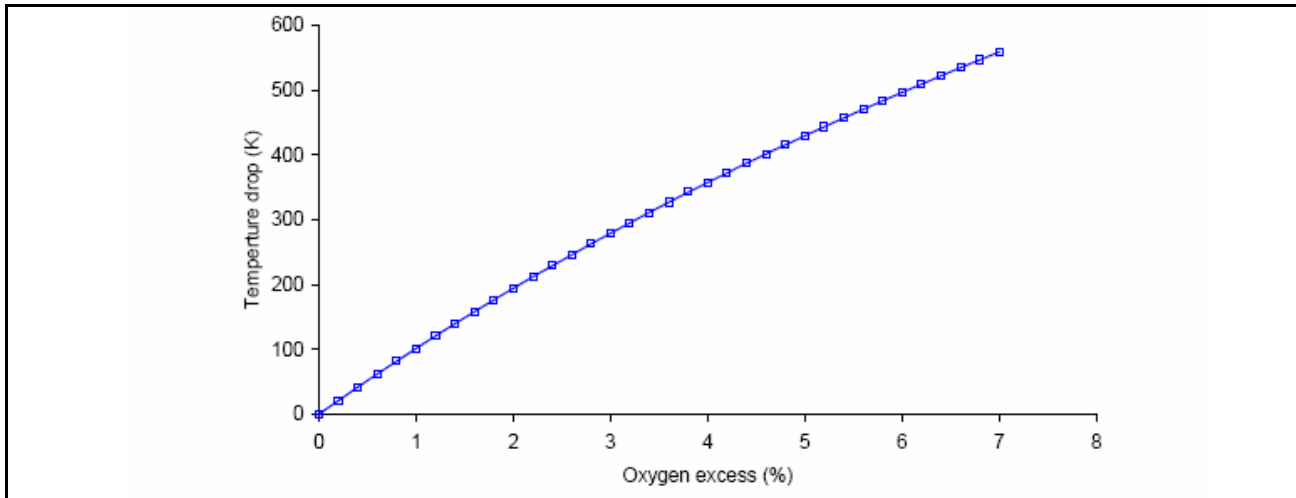

The figure above shows a theoretical calculation of drop in adiabatic (maximum theoretical) flame temperature in a methane flame as stoichiometry changes.

Temperature alarm limits can be preset on the Paragon allowing a digital switch to occur via the flame temperature relay and indicate to the BMS. The flame temperature relay can be set up to switch on temperature exceeding or reducing compared to a user threshold. In addition a 4 to 20mA signal can be monitored to remotely monitor changes in the temperature over time. The 4 to 20mA signal will mirror the LED bar display on the front of the scanner where eight LED's will = 20mA and no LED's will equal 4mA.

The Paragon communication software system allows the user to monitor and set scanner temperature readouts, zeros, spans, relay switching thresholds as well as log and trend the measured values as seen at the flame scanner.

Notes Regarding Measurement Of Flame Temperature

Most of the NO_x emissions generated by the combustion process are derived either from fuel borne nitrogen from the fuels fired or from the nitrogen in the combustion air (thermal NO_x). For natural gas-fired and No. 2 oil-fired boilers, thermal NO_x in fact represents the majority of NO_x produced from industrial boilers. Thermal NO_x emissions will increase with increasing peak flame temperatures and are affected by oxygen availability in the boiler combustion zone.

The rate of burnout in the combustion process is very sensitive to temperature. If flame temperature is increased by 10% the burnout rate doubles thereby increasing production of NO_x gases tenfold when sufficient O₂ is available.

OPERATING AND PROGRAMMING THE PARAGON FLAME SCANNER

Keypad Layout:

The Paragon flame scanner uses a combination of informative LED status indications together with four (4) pushbuttons for programming the scanner. The layout is depicted below.

Status Indication: 20 LEDs

“Ready” (1 yellow)

“Learn Target Flame” (1 yellow)

“Learn Background Flame” (1 yellow)

“Flame On/Off” (1 yellow)

“Flame Strength” (8 orange) (also used for password entry)

“Flame Temperature” (8 orange)

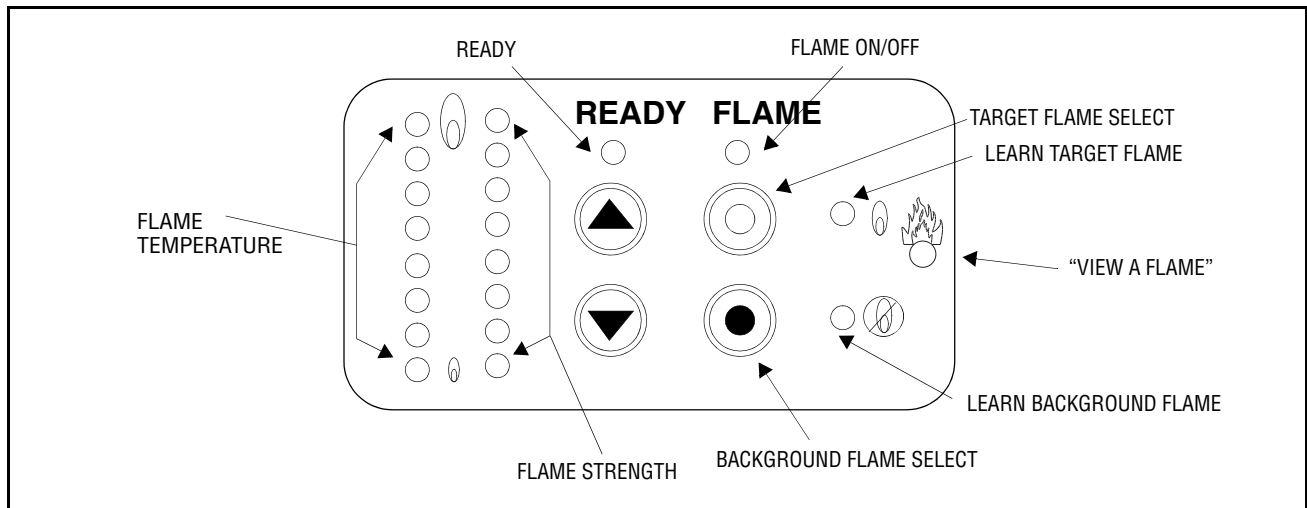

Pushbutton Functions

UP/DOWN

The UP and DOWN buttons are used to select the password prior to programming and to initiate the “learn” or store process for Target Flame and or optional Background Flame.

TARGET FLAME SELECT

The Target Select button is used to begin the “learn” or store process for the target flame. This will automatically set all the necessary switching thresholds for flame on and off recognition.

BACKGROUND FLAME SELECT (used optionally)

Should the application have background flame present, it may be desired to set up the scanner to discriminate this from the Target Flame. The background select button is used to begin the “learn” or store process for the Background Flame. This will automatically shift the “off” threshold (set during the Target Flame Select procedure) to exclude the background condition.

PRE-COMMISSIONING SETTINGS

FFRT Set-Up Description

Using the keypad the scanner flame failure response time can be set by the user to the desired timing. Each unit comes from the factory pre-set at 1 second. To change the factory default to a different FFRT see Set-Up Procedure below. To verify the current FFRT setting, press and hold the UP push button with the scanner in the normal operating mode. The “flame strength” LED set will display 1st, 2nd, 3rd or 4th LED as appropriate and these correspond to the FFRT in seconds.

Note: The maximum allowable FFRT setting is determined by local safety code, and is factory selected at 1 second.

FFRT Set-Up Procedure

If the Flame Failure Response Time needs modifying, follow the procedure listed below.

Press both the **Target Flame Select** and **Background Flame Select** buttons simultaneously.

Use the up button to drive the LEDs until LED number 8 (pass code) is illuminated on the flame strength LEDs right hand set.

Press both the **Target Flame Select** and **Background Flame Select** buttons simultaneously.

Press UP or DOWN push buttons to select required FFRT (the selected FFRT is displayed on the flame strength LEDs as either 1st, 2nd, 3rd or 4th). Once you have selected the correct value, Press both the **Target Flame Select** and **Background Flame Select** buttons simultaneously to store. The stored value can be displayed and checked at any time while in the normal run mode. Pressing and holding the UP pushbutton at any time will display the stored FFRT on the flame LEDs right hand set.

Verifying Which Operating File is in Use

Each Paragon flame scanner is equipped with four independent operating memories called files. Each file can be set with unique settings for maximizing the scanner discriminating capability. For example a file could be used for each fuel fired or for variable operating conditions. Using the keypad the current scanner flame failure response time can be verified. Each unit comes from the factory pre-set to operate on file F1. To change the operating file requires remote switching of the remote file select wiring. Refer to Fig. 6 wiring diagram and Note 2 on page 11. To verify the current file setting, press and hold the UP push button with the scanner in the normal operating mode. The “temp” LED set will display 1st, 2nd, 3rd or 4th LED as appropriate and these correspond to the current selected file in use.

If no set up information has been entered into a particular file (no flame condition learned or stored) the scanner will indicate this on power up via a flashing READY LED.

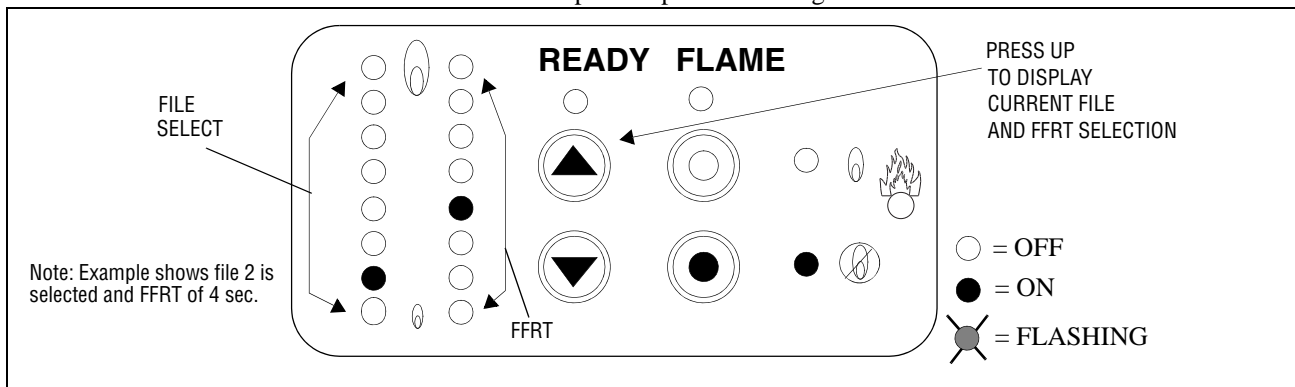

Setting up and verifying the scanner communication address (for use with Paragon Lite and Paragon Explorer software programs)

Each unit comes from the factory pre-set to operate on address 1 and this can be modified through the PC software. Using the keypad the current scanner selected communication address can be verified. Press the DOWN push button with the scanner in the normal operating mode. The "flame temperature" LED set will display the scanner address as a binary code. For example only the lower LED illuminated would indicate an address of 1. If the lowest two LED's were illuminated this

would indicate address 3 (1 + 2). If all the LED's are illuminated this would indicate address 255 (1+2+4+8+16+32+64 +128).

In order to facilitate direct communications, address 1 can be used on all new devices for setting up (from factory) and while the DOWN pushbutton is depressed the scanner will communicate on address 255 for troubleshooting and diagnostics.

COMMISSIONING THE SCANNER, LEARNING THE FLAME CONDITION

Step 1 – Enter the pass code

Press both the **Target Flame Select** and **Background Flame Select** buttons simultaneously.

Use the up button to drive the LEDs until LED number 5 (pass code) is illuminated on the flame strength LEDs right hand side (if you pass the required point use the down button to correct).

Press both the **Target Flame Select** and **Background Flame Select** buttons simultaneously.

LED indication at this point:

- Ready = Flashing
- Flame On/Off LED = OFF
- Flame Learn LED = Flashing
- Background Learn LED = Flashing

PASS CODE ACCEPTED

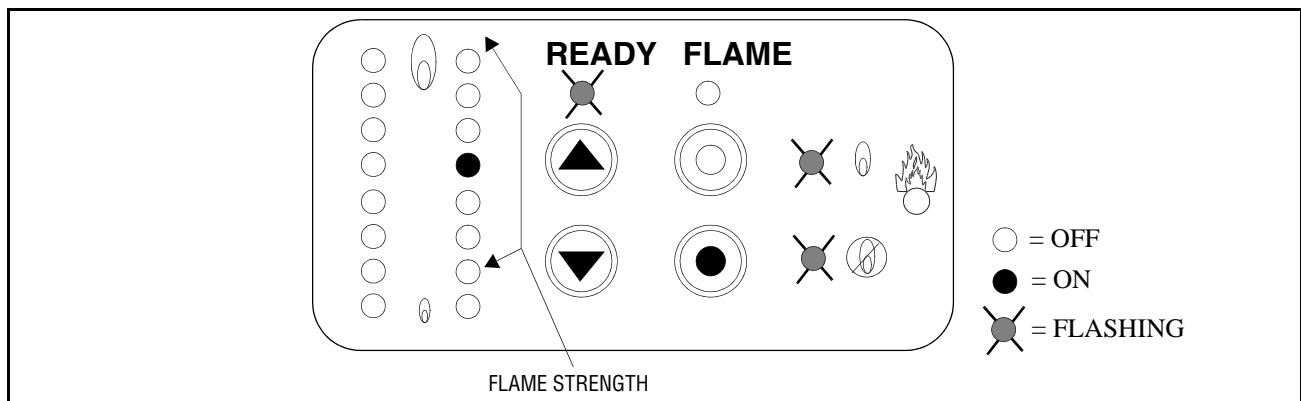

Step 2 – Learn/ Store the Target Flame

Press the Target Flame select button (the Learn Target Flame LED illuminates). Note also that the flame relay output is energized when the Target Flame Select button is depressed. This is to allow the Paragon Scanner to signal flame present to the BMS during commissioning.



WARNING: Flame must be present during scanner setup. Verify flame condition prior to depressing the Target Flame select button and energizing the flame relay output. During the setup process, run the flame at the lowest acceptable setting for flame on condition, e.g. low fire or pilot if the scanner is required to detect the condition. The scanner is at maximum gain during this mode.

Note: There is a time limit function associated with manual use of the flame relay output. If this time period is exceeded, repeat from step one.

Keeping the target flame button depressed, use the flame strength LEDs to adjust the scanner “aim” to get the highest signal (1 LED is the lowest, 8 LEDs are the highest).

During the AIM mode the scanner is automatically set to the highest gain to assist the sighting process

Look for 3 to 4 LEDs as a minimum, all may be illuminated.

LED indication at this point:

- Ready = Flashing
- Flame On/Off LED = ON

Flame Learn LED = ON

Background Learn LED = OFF

Press either the UP or DOWN pushbutton once to learn or store the selected flame.

Note: The “Ready” and “Target Flame” LEDs flash during the learn or store process until it has been completed.

During the LEARN mode the scanner is automatically adjusted to **minimum** gain and will then adjust itself up to the optimum gain position for the sighted flame. There should be no more the 7 LEDs lit. The LEDs will show the signal strength drop down and then go up. If more than 7 LEDs are lit there is too much optical energy. The scanner should be resighted or neutral density filters used. These filters will remove any excess light.

Duration of setup should take less than 2 minutes.

LEARNING THE TARGET FLAME

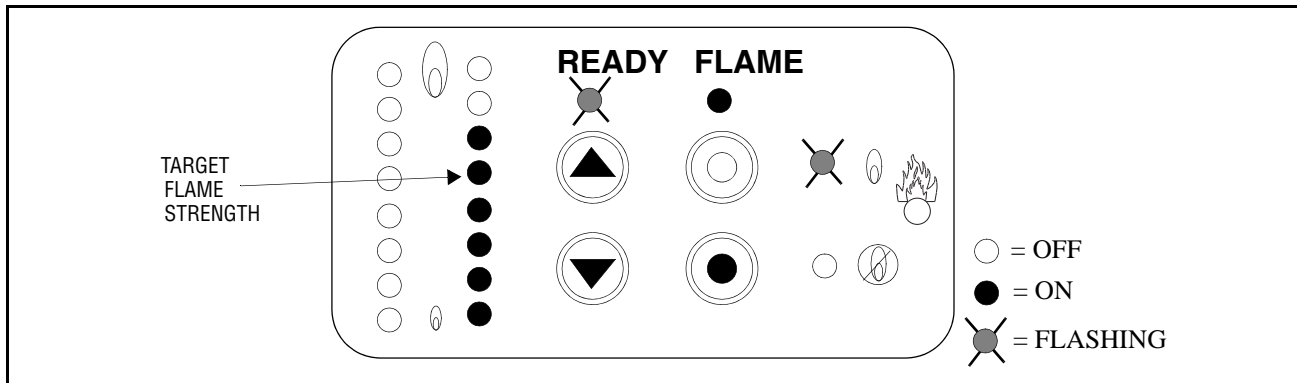

Note: Step 1 and Step 2 must be completed as a minimum to operate the scanner. Once Step 2 “Learn/Store the Target Flame” is completed the scanner will automatically set all flame switching thresholds. This would apply to a single flame application. Optionally Step 3 “Learn/Store the Background Flame” can be used to adjust the off switching threshold to discriminate a background flame condition. Refer to Step 3.

Table 3: Examples of Flame Detection Thresholds (Learning Target Flame Only)

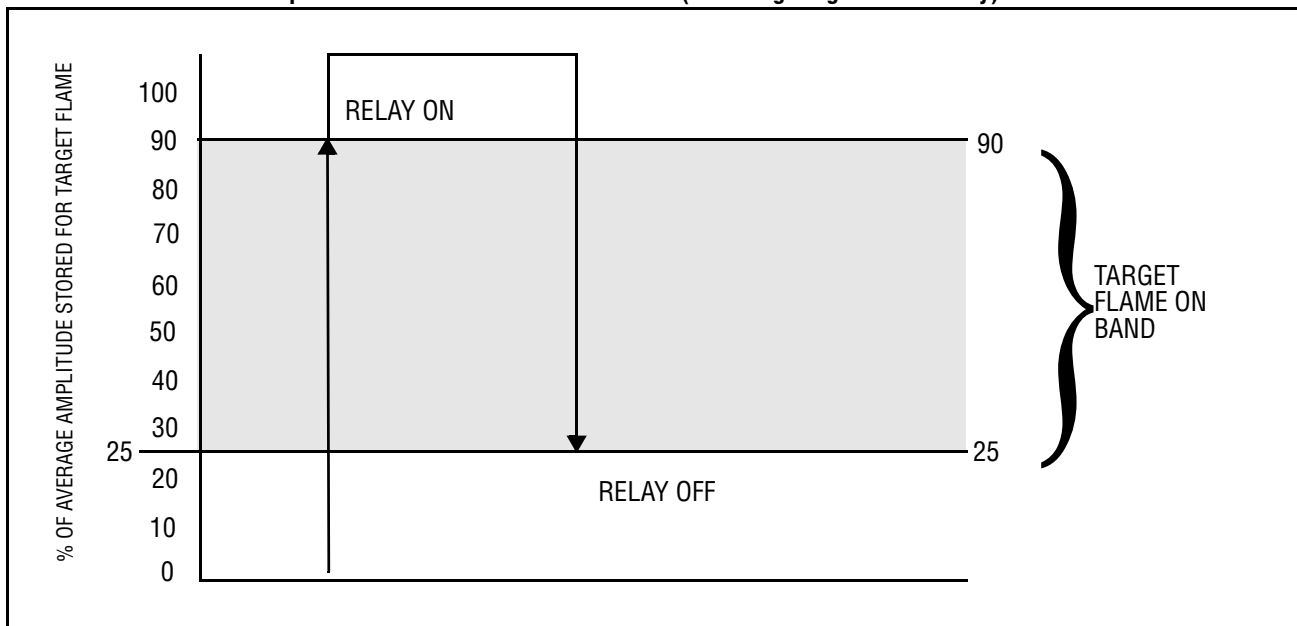

Step 3 – Learn/ Store the Background Flame (optional, see note on page and Table 4 on page 20).

Note: Use Step 1 instructions on page 17 to enter the pass code before Step 3 can be carried out.

Press the background flame select button (the Learn Background Flame LED illuminates) to learn the selected background.

LED indication at this point:

- Ready = Flashing
- Flame On/Off LED = OFF
- Flame Learn LED = OFF
- Background Learn LED = ON

Note: The “Ready” LED flashes and the “Background Flame” LED is on steady during the learn process until it has been completed.



WARNING: After parameter set-up, proper flame detection and discrimination must be verified. The flame relay must reliably de-energize for all flame off situations in any operation condition of the burner.

LEARNING THE BACKGROUND FLAME

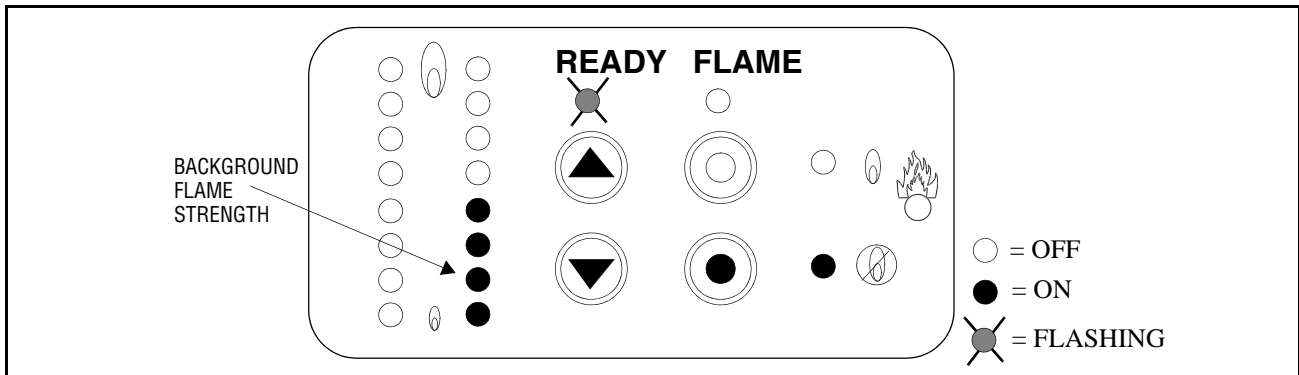

Step 4 – Setting the Temperature Ranges and Temperature Operation

The Paragon Scanner is shipped from the factory with temperature ranges pre-set at factory defaults. The temperature lower and upper limits, the 4 to 20mA lower and upper limits and the switching thresholds for the temperature relay as well as filtering for the temperature reading can all be adjusted using the Paragon Explorer or Paragon Lite software. Bulletin CU-111 explains the operating procedure for setting up the scanner using the PC based Explorer programs.

The factory defaults are listed below:

- Temperature range = 1832 to 3632° F (1000 to 2000° C)
- Temperature 4 to 20mA ranges and LED Scale = 1832 to 3632° F (1000 to 2000° C)
- Temperature relay on threshold = 3632° F (2000° C)
- Temperature relay off threshold = 1832° F (1000° C)
- Filtering level = 8 seconds

FILE	DEFAULT FUEL TYPE (to optimize temperature measurement)
1	GAS - BLUE FLAMES
2	GAS - YELLOW FLAMES
3	OIL/COAL FLAMES
4	OIL/COAL FLAMES

Table 4: Examples of Flame Detection Thresholds (Adjusted for Learned Background Flame)

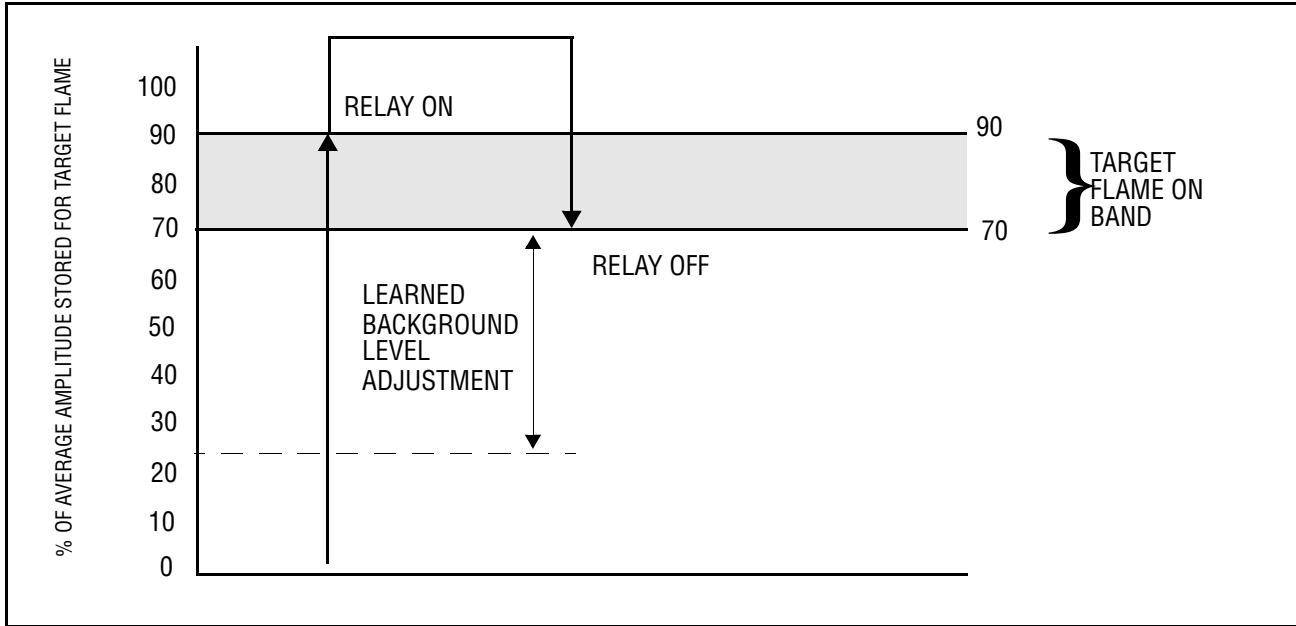

CAUTION: When aiming the Paragon Scanner, avoid sighting hot refractory surfaces such as furnace walls located behind the main flame.

Hot refractory surfaces emit IR energy and can cause extended FFRT times in certain circumstances.

Some possible solutions to address this potential problem:

- Learning main flame at high fire
- Learning the hot refractory as a background level

*Note: All eight flame LEDs should **not** be lit constantly except during high firing rates. Better performance and more reliable operation should have at least one or more LEDs turned off or in transition (ON/OFF). If all eight LEDs are constantly lit, perform a learn flame on at a higher firing rate.*

PARAGON SET UP PROCEDURE/LED INDICATION

TASK	ACTIONS	LED STATUS				
		Flame Strength (8)	Ready	Flame On/Off	Learn Target Flame	Learn Background Flame
RUN	(none)	All Active	ON	Active	OFF	OFF
Enter Password	Simultaneously depress: Target Flame Select and Background Flame Select buttons, then release	Disabled	ON	Active	ON	ON
	Depress and release: UP button five times	5th ON	ON	Active	ON	ON
Accept Password	Simultaneously depress: Target Flame Select and Background Flame Select buttons, then release	5th ON	FLASH	Active	FLASH	FLASH
Aim Scanner	Depress and hold*: Target Flame Select button Adjust scanner alignment for flame maximum signal then secure scanner position.	All Active	FLASH	ON *(RF is energized if Target Flame Select button is held)	ON	OFF
Learn Target Flame	Depress and release: UP or DOWN button while holding Target Flame Select button*	All Active	FLASH	ON *(RF is energized if Target Flame Select button is held)	FLASH	OFF
	Learn Target Flame completed	All Active	ON	Active	OFF	OFF
Learn Background Flame (if required)	Enter and Accept Password as described above	5th ON	FLASH	Active	FLASH	FLASH
	Depress and release: Background Flame Select button	All Active	FLASH	Active	OFF	ON
	Learn Background Flame completed	All Active	ON	Active	OFF	OFF
RUN	(none)	All Active	ON	Active	OFF	OFF



***WARNING:** *Depressing and holding* the “Target Flame Select” button during the AIM and Learn Target Flame procedures will keep the flame relay contacts closed, allowing the burner to operate without bypassing the burner management system input. **During this process you must visually confirm that the flame is present.** Only when the “Target Flame Select” button is released will the flame relay status be determined by the actual flame signal strength













UNDERSTANDING THE PARAGON ERROR CODES

The eight Flame Strength LEDs provide a dual function. In the event of a scanner error condition, they provide a binary code to indicate the type of error.

Note: To reset a fault press any key. If fault does not clear, consult factory.

● = LED ON ○ = LED OFF

LED	SCANNER ERROR CODES	LED	SCANNER ERROR CODES
○ ○ ○ ○ ○ ○ ○ ●	FLAME FAILURE Reserved for future use. Fault Code 1	○ ○ ○ ○ ○ ○ ○ ● ○	PLD FAILURE Logic device has failed, internal error. Fault Code 2
○ ○ ○ ○ ○ ○ ○ ● ●	SINGLE SOURCE Single flicker frequency source has been detected. This is identified as not a genuine flame. Fault Code 3	○ ○ ○ ○ ○ ○ ○ ● ○ ○	OVER RANGE IR emissions had too much energy. Use neutral density filter or alternate sighting position if this happens during a learn. If this occurs during a background learn, then background level is too high for a background learn. Fault Code 4
○ ○ ○ ○ ○ ○ ○ ○ ● ●	UNDER RANGE IR emissions had too little energy. Note: It is possible this error can also occur in the case of too little signal during Learning Flame On. Fault Code 5	○ ○ ○ ○ ○ ○ ○ ○ ○ ○	MIN. LOAD PW FAILURE Reserved for future use. Fault Code 6
○ ○ ○ ○ ○ ○ ○ ○ ○ ○	MAX. LOAD PW FAILURE Reserved for future use. Fault Code 7	○ ○ ○ ○ ○ ○ ○ ○ ○ ○	E EPROM FAILURE Internal learn memory failure. Unit cannot store values. Fault Code 8
○ ○ ○ ○ ○ ○ ○ ○ ○ ○	EXECUTION FAILURE Reserved for future use. Fault Code 9	○ ○ ○ ○ ○ ○ ○ ○ ○ ○	CPU FAILURE Reserved for future use. Fault Code 10

LED	SCANNER ERROR CODES	LED	SCANNER ERROR CODES
	<p>FLAME RELAY Internal diagnostics has detected a fault on the flame relay.</p> <p>Note: Faults detected on the flame relay itself will operate the fault relay to remove signal to the BMS.</p> <p>Fault Code 11</p>		<p>FAULT RELAY Internal diagnostics has detected a failure on the fault relay.</p> <p>Fault Code 12</p>
	<p>RMEM FAILURE Reserved for future use.</p> <p>Fault Code 13</p>		<p>IO ENABLE FAULT Internal diagnostics has detected a fault on the internal IO.</p> <p>Fault Code 14</p>
	<p>TEMP. FAULT Scanner has exceeded maximum internal temperature of 185°F (85°C).</p> <p>Fault Code 15</p>		<p>NEG 5 FAULT Internal reading is out of range.</p> <p>Fault Code 16</p>
	<p>PLUS 5 FAULT Internal reading is out of range.</p> <p>Fault Code 17</p>		<p>VREF FAULT Power supply reference out of range</p> <p>Fault Code 18</p>
	<p>GROUND FAULT Noise is being detected on the analog ground</p> <p>Fault Code 19</p>		<p>LOGIC VOLTAGE FAULT 3.3 volt power supply reference is out of range.</p> <p>Fault Code 20</p>

LED	SCANNER ERROR CODES	LED	SCANNER ERROR CODES
<input type="radio"/> <input type="radio"/> <input type="radio"/> <input checked="" type="radio"/> <input type="radio"/> <input checked="" type="radio"/> <input type="radio"/> <input checked="" type="radio"/>	SPI FAILURE Internal learn memory failure. Fault Code 21	<input type="radio"/> <input type="radio"/> <input type="radio"/> <input checked="" type="radio"/> <input type="radio"/> <input checked="" type="radio"/> <input type="radio"/>	AIM MODE TIMEOUT Two minute maximum duration has been exceeded. Restart learning procedure, see step one. Fault Code 22
<input type="radio"/> <input type="radio"/> <input type="radio"/> <input checked="" type="radio"/> <input type="radio"/> <input checked="" type="radio"/> <input checked="" type="radio"/> <input checked="" type="radio"/>	CALIBRATION TIMEOUT Factory calibrate only. Fault Code 23		

LED	TEMPERATURE DISPLAY
<input checked="" type="radio"/> <input type="radio"/> <input type="radio"/> <input type="radio"/> <input type="radio"/> <input type="radio"/> <input type="radio"/> <input checked="" type="radio"/>	out of range

ACCESSORIES

Neutral Density Filters

PART NUMBER	FILTER KIT
129-184-32	32% Transmission Filter Kit
129-184-10	10% Transmission Filter Kit
129-184-5	5% Transmission Filter Kit
129-184-1	1% Transmission Filter Kit

The Paragon scanner has been designed to operate on multiple fuels and has an onboard electronic gain adjustment of around 1000 to 1 for that purpose. This allows the scanner to adjust automatically to compensate for flames ranging from small low energy gaseous fuels to large high energy oils and coals.

The OIL/COAL is a low range optical gain. The Gas is a 5X high range optical gain.

There are occasions where some fuels may emit very high energy and in this event the use of neutral density filters is recommended. Fireeye has designed a series of filters that can be purchased as a kit. Each filter provides a measured percentage reduction in the light it passes to the scanner. These are simply placed in front of the scanner.

To determine if the filters are required for the application refer to the instructions in the Learn Procedure steps on pages 16 to 18.

NEUTRAL DENSITY FILTER LAYOUT

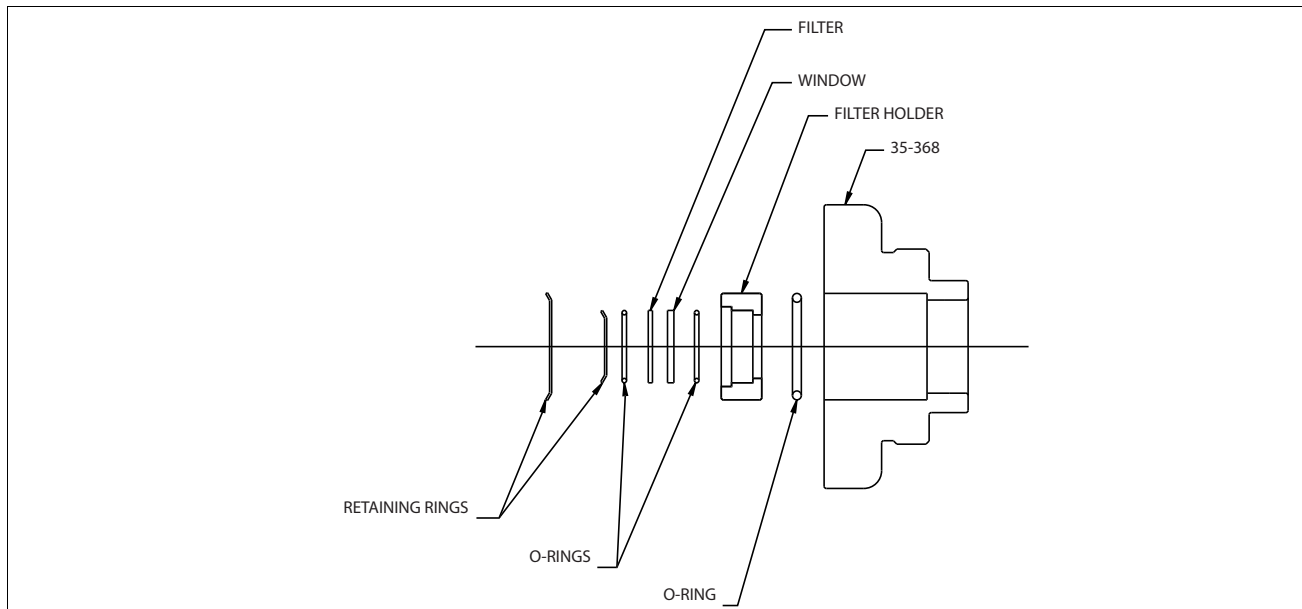

Orifices

Because of the unique configuration of the Paragon detection sensors, orifices are not recommended unless they can be positioned more than 3 feet from the scanner. Neutral density filters are therefore the preferred option if the flame criteria is outside the range of the scanner's on board adjustments.

The orifice restricts the field of view (target area), reduces and maintains air flow, maintains air block and increases discrimination between flame and background radiation. The orifice is secured within the ball of a swivel mount with an orifice retainer. The orifice can also be placed within a one inch union (not provided). The orifice must be at least 3 feet from scanner. The scanner should ideally sight a target area of 4 to 25 square inches (25-150 cm²) of the flame front. The flame front is a plane within the combustion space separating the region of unburned fuel from the burning fuel.

Note: There is an inverse relationship between discrimination and sensitivity.

Heat Insulating Nipple

The heat insulating nipple P/N 35-127-3 (BSP) or 35-127-1 (NPT) prevents heat transfer from the hot sight pipe to the scanner head.

Sealing Coupling with Quartz Window

The sealing coupling (60-1199-1) is used whenever a coupling or seal is required for scanner piping. The size is one inch US standard taper pipe thread (1" NPT). The sealing coupling has a quartz window to block off the scanner from the furnace pressure and heat. When the sealing coupling is used, the 1" tee/wye is used for the purge air inlet. Be sure the quartz window is properly seated to seal off the scanner. Do not overtighten coupling collar because damage to the window may result. For best results, hand tighten coupling collar.

FIGURE 9.

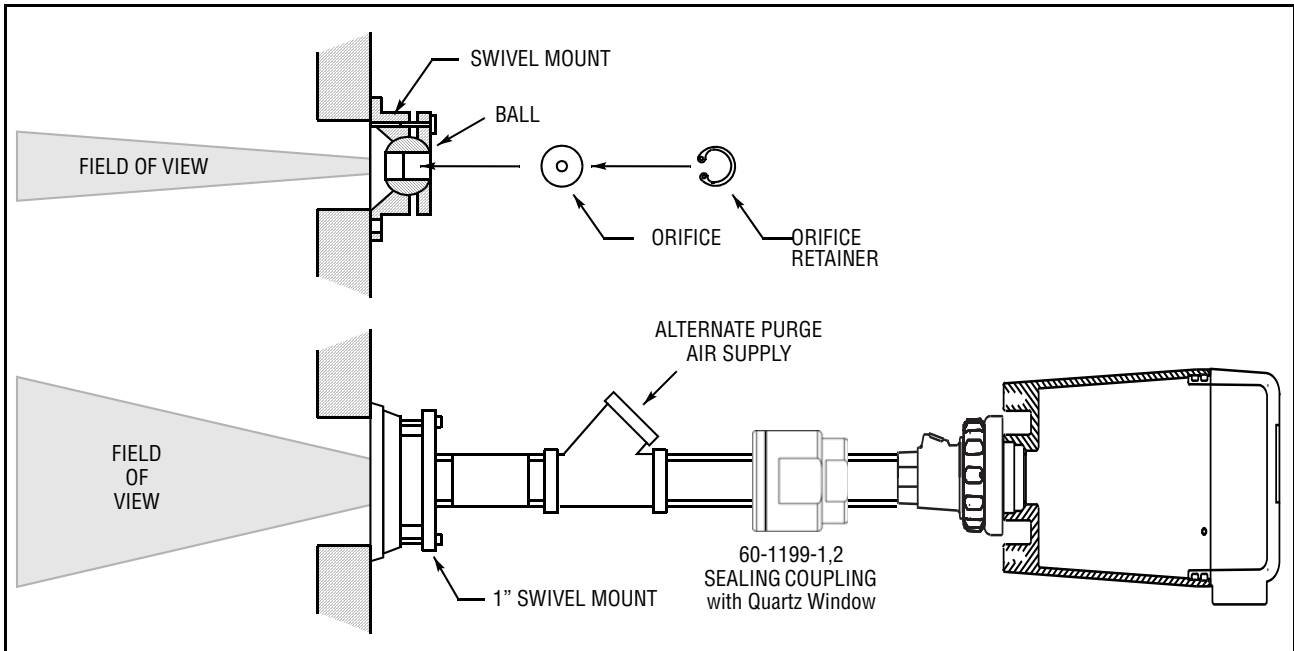

FIGURE 10.

- A. THROUGH I. ORIFICES .062 DIA TO .5 DIA
- J. 34-181 ORIFICE RETAINER
- K. 35-127-1 (NPT) HEAT INSULATING NIPPLE
- 35-127-3 (BSP) HEAT INSULATING NIPPLE
- L. 92-48 QUARTZ WINDOW (for 60-1199 Sealing Coupling shown in Fig. 11).

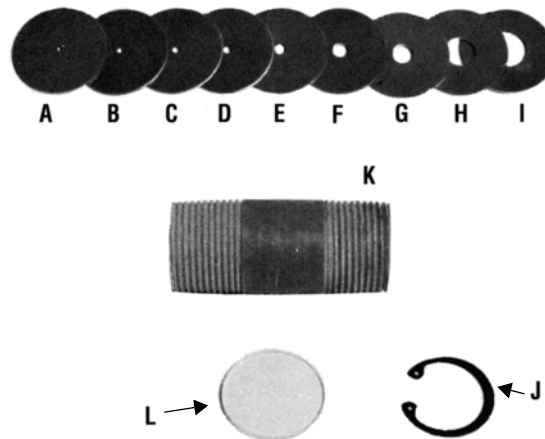
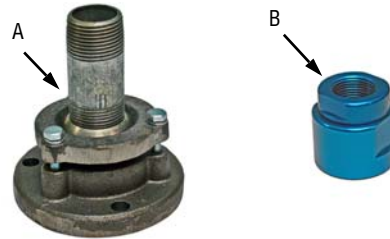

FIGURE	PART NUMBER	DESCRIPTION
9(A-J)	53-121	Orifice Set
9A	53-121-2	Orifice .062" Diameter
9B	53-121-3	Orifice .078" Diameter
9C	53-121-4	Orifice .093" Diameter
9D	53-121-5	Orifice .109" Diameter
9E	53-121-6	Orifice .125" Diameter
9F	53-121-7	Orifice .187" Diameter
9G	53-121-8	Orifice .250" Diameter
9H	53-121-9	Orifice .375" Diameter
9I	53-121-10	Orifice .50" Diameter
5	35-200	1" Wye

FIGURE 11.

- A. 60-1664-3 (NPT) SWIVEL MOUNT
 60-1664-4 (BSP) SWIVEL MOUNT
 B. 60-1199-1 (NPT) SEALING COUPLING W/QUARTZ WINDOW
 60-1199-2 (BSP) SEALING COUPLING W/QUARTZ WINDOW



MAINTENANCE

1. The control and scanner should be powered at all times (except for repair, cleaning or replacement) to reduce any harmful effects of atmospheric humidity.
2. The scanner and sight pipe must be kept clean to prevent overheating and assure optical qualities.



NOTICE

When Fireeye products are combined with equipment manufactured by others and/or integrated into systems designed or manufactured by others, the Fireeye warranty, as stated in its General Terms and Conditions of Sale, pertains only to the Fireeye products and not to any other equipment or to the combined system or its overall performance.

WARRANTIES

FIREYE guarantees for *one year from the date of installation or 18 months from date of manufacture* of its products to replace, or, at its option, to repair any product or part thereof (except lamps and photocells) which is found defective in material or workmanship or which otherwise fails to conform to the description of the product on the face of its sales order. **THE FOREGOING IS IN LIEU OF ALL OTHER WARRANTIES AND FIREYE MAKES NO WARRANTY OF MERCHANTABILITY OR ANY OTHER WARRANTY, EXPRESS OR IMPLIED.** Except as specifically stated in these general terms and conditions of sale, remedies with respect to any product or part number manufactured or sold by Fireeye shall be limited exclusively to the right to replacement or repair as above provided. In no event shall Fireeye be liable for consequential or special damages of any nature that may arise in connection with such product or part.



FIREYE®
3 Manchester Road
Derry, New Hampshire 03038 USA
www.fireeye.com

CU-108
NOVEMBER 25, 2013
Supersedes April 11, 2013