

# 3RB2 Solid-State Overload Relays

3RB22, 3RB23 for high-feature applications

## Overview

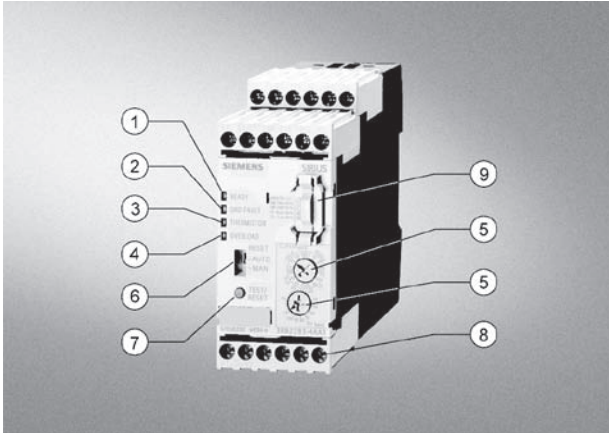

3RB22/3RB23 evaluation module

- (1) Green "Ready" LED:  
A continuous green light signals that the device is working correctly.
- (2) Red "Ground Fault" LED:  
A continuous red light signals a ground fault.
- (3) Red "Thermistor" LED:  
A continuous red light signals an active thermistor trip.
- (4) Red "Overload" LED:  
A continuous red light signals an active overload trip; a flickering red light signals an imminent trip (overload warning).
- (5) Motor current and trip class adjustment:  
Setting the device to the motor current and to the required trip class dependent on the starting conditions is easy with the two rotary knobs.
- (6) Selector switch for manual/automatic RESET:  
With this switch you can choose between manual and automatic RESET.
- (7) Test/RESET button:  
Enables testing of all important device components and functions, plus resetting of the device after a trip when manual RESET is selected.
- (8) Connecting terminals (removable terminal block):  
The generously sized terminals permit connection of two conductors with different cross-sections for the auxiliary, control and sensor circuits. Connection is possible with screw-type terminals and alternatively with spring-loaded terminals.
- (9) 3RB29 85 function expansion module:  
Enables more functions to be added, e.g. internal ground fault detection and/or an analog output with corresponding signals.

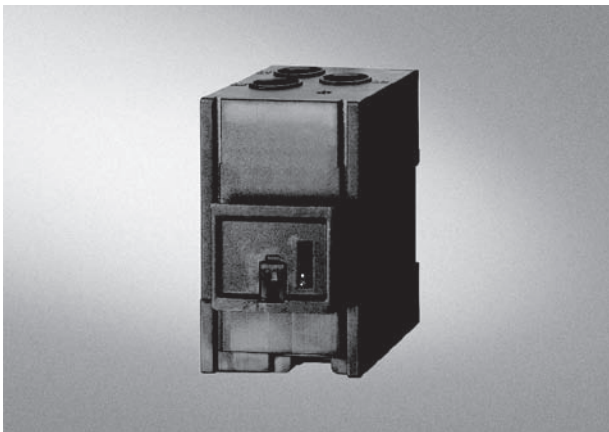

3RB29 06 current measuring module

The modular, solid-state overload relays with external power supply type 3RB22 (with monostable auxiliary contacts) and type 3RB23 (with bistable auxiliary contacts) up to 630 A (up to 820 A possible with a series transformer) have been designed for inverse-time delayed protection of loads with normal and heavy starting (see Function) against excessive temperature rises due to overload, phase unbalance or phase failure. An overload, phase unbalance or phase failure result in an increase of the motor current beyond the set motor rated current. This current rise is detected by means of a current measuring module and electronically evaluated by a special evaluation module which is connected to it. The evaluation electronics sends a signal to the auxiliary contacts. The auxiliary contacts then switch off the load by means of the contactors control circuit. The break time depends on the ratio between the tripping current and set current  $I_{\text{e}}$  and is stored in the form of a long-term stable tripping characteristic (see Characteristic Curves). The "tripped" status is signaled by means of a continuous red "Overload" LED.

The LED indicates imminent tripping of the relay due to overload, phase unbalance or phase failure by flickering when the limit current has been violated. This warning can also be used as a signal through auxiliary contacts.

In addition to the described inverse-time delayed protection of loads against excessive temperature rise, the 3RB22/3RB23 solid-state overload relays also allow direct temperature monitoring of the motor windings (full motor protection) by failsafe connection of a PTC sensor circuit. With this temperature-dependent protection, the loads can be protected against overheating caused indirectly by reduced coolant flow, for example, which cannot be detected by means of the current alone. In the event of overheating, the devices signal the contactor to switch off, and thus the load, by means of the auxiliary contacts. The "tripped" status is signaled by means of a continuous red "Thermistor" LED.

To also protect the loads against high-resistance short-circuits due to damage to the insulation, humidity, condensed water, etc., the 3RB22/3RB23 solid-state overload relays offer the possibility of internal ground fault monitoring in conjunction with a function expansion module; not possible in conjunction with a contactor assembly for Wye-Delta starting). In the event of a ground fault the 3RB22/3RB23 relays trip instantaneously. The "tripped" status is signaled by means of a red "Ground Fault" LED. Signaling through auxiliary contacts is also possible.

After tripping due to overload, phase unbalance, phase failure, thermistor tripping or ground fault, the relay may be reset manually or automatically after the recovery time has elapsed (see Function).

In conjunction with a function expansion module the motor current measured by the microprocessor can be output in the form of an analog signal 4 ... 20 mA DC for operating rotary coil instruments or for feeding into analog inputs of programmable logic controllers. With an additional AS-Interface analog module the current values can also be transferred over the AS-i bus system.

The devices are manufactured in accordance with environmental guidelines and contain environmentally friendly and reusable materials.

They comply with important worldwide standards and approvals.

# 3RB2 Solid-State Overload Relays

3RB22, 3RB23 for high-feature applications

## Benefits

The most important features and benefits of the 3RB22/3RB23 solid-state overload relays are listed in the overview table (see [Overload Relays, General Data](#)).

## Application

### Industries

The 3RB22/3RB23 solid-state overload relays are suitable for customers from all industries who want to provide optimum inverse-time delayed and temperature-dependent protection of their electrical loads (e.g. motors) under normal and heavy starting conditions (CLASS 5 to CLASS 30), minimize project completion times, inventories and power consumption, and optimize plant availability and maintenance management.

### Application

The 3RB22/3RB23 solid-state overload relays have been designed for the protection of three-phase asynchronous and single-phase AC motors.

If single-phase AC motors are to be protected by the 3RB22/3RB23 solid-state overload relays, the main circuits of the current measuring modules must be series-connected.

### Ambient conditions

The devices are insensitive to external influences such as shocks, corrosive environments, ageing and temperature changes.

For the temperature range from  $-25\text{ °C}$  to  $+60\text{ °C}$ , the 3RB22/3RB23 solid-state overload relays compensate the temperature according to IEC 60947-4-1.

Configuration notes for use of the devices below  $-25\text{ °C}$  or above  $+60\text{ °C}$  on request.

## "Increased safety" type of protection EEx e according to ATEX guideline 94/9/EC

The 3RB22/3RB23 solid-state overload relays are suitable for the overload protection of explosion-proof motors with "increased safety" type of protection EEx e. The relays meet the requirements of EN 60079-7 (Electrical apparatus for potentially explosive atmospheres – Increased safety "e").

When using 3RB23 solid-state overload relays for the protection of EEx e motors, separate monitoring of the control supply voltage is recommended.

The basic safety and health requirements of ATEX guideline 94/9/EG are fulfilled by compliance with

- EN 60947-1
- EN 60947-4-1
- EN 60947-5-1
- EN 60079-14

EU type test certificate for Group II, Category (2) G/D under application. Number on request.

## Accessories

The following accessories are available for the 3RB22/3RB23 solid-state overload relays:

- A sealable cover for the evaluation module
- Box terminal blocks for the current measuring modules size S6 and S10/S12
- Terminal covers for the current measuring modules size S6 and S10/S12
- Push-in lugs for screw (panel) mounting the size S00 to S3 current measuring modules

# 3RB2 Solid-State Overload Relays



3RB22, 3RB23 for high-feature applications

**3RB22/3RB23 solid-state overload relays for full motor protection with screw connection or spring-loaded terminals for stand-alone installation, CLASS 5, 10, 20 and 30 adjustable**

Features and technical specifications:

- Overload protection, phase failure protection and unbalance protection
- External power supply 24 ... 240 V AC/DC
- Auxiliary contacts 2 NO +2 NC
- Manual and automatic RESET
- Electrical remote RESET integrated
- 4 LEDs for operating and status displays
- TEST function and self-monitoring
- Internal ground fault detection with function expansion module
- Screw connection or spring-loaded terminals for auxiliary, control and sensor circuits
- Input for PTC sensor circuit
- Analog output with function expansion module

| Size Contactor | Version | Connection type | Order No. | Weight per PU approx. kg |
|----------------|---------|-----------------|-----------|--------------------------|
|----------------|---------|-----------------|-----------|--------------------------|

| Evaluation modules  |             |            |                         |                            |
|---|-------------|------------|-------------------------|----------------------------|
|  <p>3RB2. 83-4AA1</p>  | S00 ... S12 | Monostable | Screw connection        | <b>3RB22 83-4AA1</b> 0.300 |
|   |             |            |                         | Spring-loaded terminals    |
|   |             | Bistable   | Screw connection        | <b>3RB23 83-4AA1</b> 0.300 |
|   |             |            | Spring-loaded terminals | <b>3RB23 83-4AC1</b> 0.300 |
|  <p>3RB2. 83-4AC1</p> |             |            |                         |                            |

| Function expansion modules |  |   |  |                            |
|----------------------------|--|---|--|----------------------------|
| –                          |  | <b>Analog Basic 1 module<sup>1)</sup></b><br>Analog output DC 4 ... 20 mA, with overload warning  |  | <b>3RB29 85-2AA0</b> 0.030 |
|                            |  | <b>Analog Basic 1 GF module<sup>1)2)</sup></b><br>Analog output DC 4 ... 20 mA, with internal ground fault detection and overload warning       |  | <b>3RB29 85-2AA1</b> 0.030 |
|                            |  | <b>Analog Basic 2 GF module<sup>1)2)</sup></b><br>Analog output DC 4 ... 20 mA, with internal ground fault detection and ground fault signaling |  | <b>3RB29 85-2AB1</b> 0.030 |
|                            |  | <b>Basic 1 GF module<sup>2)</sup></b><br>with internal ground fault detection and overload warning  |  | <b>3RB29 85-2CA1</b> 0.030 |
|                            |  | <b>Basic 2 GF module<sup>2)</sup></b><br>with internal ground fault detection and ground fault signaling  |  | <b>3RB29 85-2CB1</b> 0.030 |

- 1) The analog signal 4 ... 20 mA DC can be used for operating rotary coil instruments or for feeding into analog inputs of programmable logic controllers.
- 2) The following information on ground fault protection refers to sinusoidal residual currents at 50/60 Hz:
- With a motor current of between 0.3 and 2 times the set current  $I_n$  the unit will trip at a ground fault current equal to 30% of the set current.
  - With a motor current of between 2 and 8 times the set current  $I_n$  the unit will trip at a ground fault current equal to 15% of the set current.
  - The trip delay amounts to between 0.5 and 1 second.





*Note: Analog input modules, e. g. SM 331, must be configured for 4-wire measuring transducers. In this case the analog input module must not supply current to the analog output of the 3RB22/ 3RB23 relay.*

For accessories, see page 3/35  
 For description, see pages 3/32-3/33  
 For technical data, see pages 3/39-3/44.  
 For dimension drawings, see pages 3/45-3/46.  
 For schematic diagrams, see page 3/47.

# 3RB2 Solid-State Overload Relays

3RB22, 3RB23 for high-feature applications

## Current measuring modules for direct mounting<sup>1)</sup> and stand-alone installation<sup>1)2)</sup>

| Size<br>Con-factor <sup>3)</sup>   | Set current value of the<br>inverse-time delayed overload trip<br>A | Order No.              | Weight per<br>PU approx.<br>kg |
|--|---|------------------------|--------------------------------|
| <b>Size S00/S0<sup>2)4)</sup></b>  |   |                        |                                |
| <br>3RB29 06-2.G1   | S00/S0  | <b>3RB29 06-2BG1</b>   | 0.100                          |
|  |   | <b>3RB29 06-2DG1</b>   | 0.150                          |
| <b>Size S2/S3<sup>2)4)</sup></b>   |   |                        |                                |
| <br>3RB29 06-2.JG1  | S2/S3   | <b>3RB29 06-2JG1</b>   | 0.350                          |
| <b>Size S6<sup>1)4)</sup></b>  |   |                        |                                |
| <br>3RB29 56-2.TG2  | S6  | with pass through CT's | <b>3RB29 56-2TG2</b>           |
|  |   | with busbar            | <b>3RB29 56-2TH2</b>           |
| <b>Size S10/S12<sup>1)</sup></b>   |   |                        |                                |
| <br>3RB29 66-2.WH2 | S10/S12 and<br>size 14 (3TF68/<br>3TF69)                            | <b>3RB29 66-2WH2</b>   | 1.750                          |

- 1) The current measuring modules with an Order No. ending with "2" are designed for direct mounting and stand-alone installation. For 3TF68/3TF69 contactors, direct mounting is not possible.  
2) The current measuring modules with an Order No. ending with "1" are designed for stand-alone installation.

- 3) Observe maximum rated operational current of the devices.  
4) The modules with an Order No. with "G" in 11th position are equipped with a straight-through transformer.

| Size<br>Contactor  | Version     | Order No.  | Weight per<br>PU approx.<br>kg                       |
|--|-------------|--|--|
| <b>Connecting cables (essential accessory)</b>   |             |  |  |
| <br>3RB29 87-2. | S00 ... S12 | For connection between evaluation module and current measuring module                |  |
|  |             | <ul style="list-style-type: none"> <li>Length 0.1 m</li> <li>Length 0.5 m</li> </ul> | <b>3RB29 87-2B</b> 0.010<br><b>3RB29 87-2D</b> 0.020 |

For description, see pages 3/36-3/37.  
For technical data, see pages 3/39-3/44.  
For dimension drawings, see pages 3/45-3/46.  
For schematic diagrams, see page 3/47.

## 3RB2 Solid-State Overload Relays

3RB22, 3RB23 for high-feature applications

**Design****Device concept**

The 3RB22/3RB23 solid-state overload relays are based on a modular device concept. Each device always comprises an evaluation module, which is independent of the motor current, and a current measuring module, which is dependent on the motor current. The two modules are electrically interconnected by a connection cable through the system interface.

The basic functionality of the evaluation module can be optionally expanded with corresponding function expansion modules. The function expansion modules are integrated in the evaluation module for this purpose through a simple plug connection.

**Mounting options****Current measuring modules**

The current measuring modules size S00/S0 and S2/S3 are designed for stand-alone installation. By contrast, the current measuring modules size S6 and S10/S12 are suitable for stand-alone installation or direct mounting.

**Evaluation modules**

The evaluation modules can be mounted either on the current measuring module (only sizes S00/S0 and S2/S3) or separately.

**Connection technique****Main circuit (current measuring module)**

For sizes S00/S0, S2/S3 and S6, the main circuit can also be connected by the straight-through transformer method. In this case, the cables of the main circuit are routed directly through the feed-through openings of the relay to the contactor terminals.

For sizes S6 and S10/S12, the main circuit can be connected with the help of the Busbar. In conjunction with the corresponding box terminals, screw terminals are also available.

**Auxiliary circuit (evaluation module)**

Connection of the auxiliary circuit (removable terminal block) is possible with either screw terminals or spring-loaded terminals.

**Overload relays in contactor assemblies for Wye-Delta starting**

When overload relays are used in combination with contactor assemblies for Wye-Delta starting it must be noted that only 0.58 times the motor current flows through the line contactor. An overload relay mounted onto the line contactor must be set to 0.58 times the motor current.

When 3RB22/3RB23 solid-state overload relays are used in combination with contactor assemblies for Wye-Delta starting, the function expansion modules for internal ground-fault detection must not be used.

**Operation with frequency converter**

The 3RB22/3RB23 solid-state overload relays are suitable for frequencies of 50/60 Hz and the associated harmonics. This permits the 3RB22/3RB23 overload relays to be used on the incoming side of the frequency converter.

If motor protection is required on the outgoing side of the frequency converter, the 3RN thermistor motor protection devices or the 3RU11 thermal overload relays are available for this purpose.

**Function****Basic functions**

The 3RB22/3RB23 solid-state overload relays are designed for:

- Inverse-time delayed protection of loads from overloading
- Inverse-time delayed protection of loads from phase unbalance
- Inverse-time delayed protection of loads from phase failure
- Temperature-dependent protection of loads by connecting a PTC sensor circuit
- Protection of loads from high-resistance short-circuits (internal ground-fault detection; detection of fault currents > 30 % of the set current  $I_e$ )
- Output of an overload warning
- Output of an analog signal 4 to 20 mA DC as image of the flowing motor current

The basic functions of the evaluation modules in conjunction with function expansion modules are listed in the following table:

| Evaluation module  | Function expansion module | Basic functions   |
|--|---------------------------|---|
| 3RB22 83-4AA1<br>3RB22 83-4AC1<br>3RB23 83-4AA1<br>3RB23 83-4AC1 | None                      | Inverse-time delayed protection, temperature-dependent protection, electrical remote RESET, overload warning  |
|  | 3RB29 85-2CA1             | Inverse-time delayed protection, temperature-dependent protection, internal ground-fault detection, electrical remote RESET, overload warning                   |
|  | 3RB29 85-2CB1             | Inverse-time delayed protection, temperature-dependent protection, internal ground-fault detection, electrical remote RESET, ground fault signal                |
|  | 3RB29 85-2AA0             | Inverse-time delayed protection, temperature-dependent protection, electrical remote RESET, overload warning, analog output                                     |
|  | 3RB29 85-2AA1             | Inverse-time delayed protection, temperature-dependent protection, internal ground-fault detection, electrical remote RESET, overload warning, analog output    |
|  | 3RB29 85-2AB1             | Inverse-time delayed protection, temperature-dependent protection, internal ground-fault detection, electrical remote RESET, ground fault signal, analog output |

**Control circuit**

The 3RB22/3RB23 solid-state overload relays require an external power supply (24–240 V AC/DC), i.e. an additional supply voltage is necessary.

**Short-circuit protection**

Fuses or motor starter protectors must be used for short-circuit protection. For assignments of the corresponding short-circuit protection devices to the 3RB22/3RB23 solid-state overload relays with/without contactor see [Technical Specifications and Selection and Ordering Data](#).

**Trip classes**

The 3RB22/3RB23 solid-state overload relays are suitable for normal and heavy starting. The required trip class (CLASS 5, 10, 20 or 30) can be adjusted by means of a rotary knob depending on the current starting condition.

For details of the trip classes see [Characteristic Curves](#).



# 3RB2 Solid-State Overload Relays

## 3RB22, 3RB23 for high-feature applications

### Phase failure protection

The 3RB22/3RB23 solid-state overload relays are fitted with phase failure protection (see [Characteristic Curves](#)) in order to minimize temperature rises of the load during single-phase operation.

### Setting

The 3RB22/3RB23 solid-state overload relays are set to the motor rated current by means of two rotary knobs.

- The upper rotary knob (CLASS/ $I_{e\max}$ ) is divided into 4 ranges: 1 A, 10 A, 100 A and 1000 A. The zone must be selected which corresponds to the rated motor current and the current measuring module to be used with it. With the range selected the required trip class (CLASS 5, 10, 20 or 30) can be determined.
- The lower rotary knob with percent scale (10 % ... 100 %) is then used to set the rated motor current in percent of the range selected with the upper rotary button.

### Example

- Rating of induction motor = 45 kW (50 Hz, 400 V AC)
- Rated motor current = 80 A
- Required trip class = CLASS 20
- Selected transformer: 10 to 100 A

### Solution

- Step 1: Use the upper rotary knob (CLASS) to select the 100 A range
- Step 2: Within the 100 A range set the trip class CLASS 20
- Step 3: Set the lower rotary knob to 80 % (= 0.8) of 100 A  $\times$  0.8 = 80 A.

If the current which is set on the evaluation module does not correspond to the current range of the connected current transformer, an error will result.

### Manual and automatic reset

In the case of the 3RB22/3RB23 solid-state overload relays, a slide switch can be used to choose between automatic and manual resetting.

If manual reset is set, a reset can be carried out directly on the device after a trip by pressing the blue TEST/RESET button. A remote RESET can be carried out electrically by jumpering the terminals Y1 and Y2.

If the slide switch is set to automatic RESET, the relay is reset automatically.

The time between tripping and resetting is determined by the recovery time.

### Recovery time

With the 3RB22/3RB23 solid-state overload relays the recovery time after inverse-time delayed tripping is approx. 3 minutes regardless of the selected reset mode. The recovery time allows the load to cool down.

However, in the event of temperature-dependent tripping by means of a connected PTC thermistor sensor circuit, the device can only be manually or automatically reset once the winding temperature at the installation location of the PTC thermistor has fallen 5 Kelvin below its response temperature.

After a ground fault trip the 3RB22/3RB23 solid-state overload relay trips can be reset immediately without a recovery time.

### TEST function

The combined TEST/RESET button can be used to check whether the relay is working correctly. The test can be aborted at any time by letting go of the TEST/RESET button.

LEDs, the device configuration (this depends on which expansion module is plugged in) and the device hardware are tested while the button is kept pressed for 6 seconds. Simultaneously and for another 18 seconds a direct current proportional in size to the maximum phase of the main current is fed in at the terminals I(+) and I(-). By comparing the analog signal, which is to be measured, with the main current, the accuracy of the current measurement can be determined. In this case 4 mA corresponds to 0 % and 20 mA to 125 % of the set current. After 24 seconds the auxiliary contacts are switched and the feeder switch off as the result, bringing the test to an end.

After a test trip a faultless relay is reset by pressing the TEST/RESET button. If a hardware fault is detected, the device trips and cannot be reset.

### Self-monitoring

The 3RB22/3RB23 solid-state overload relays have a self-monitoring feature, i.e. the devices constantly monitor their own basic functions and trip if an internal fault is detected.

### Display of the operating status

The particular operating status of the 3RB22/3RB23 solid-state overload relays is displayed by means of four LEDs:

- Green "Ready" LED: A continuous green light signals that the overload relay is ready for operation. The 3RB22/3RB23 overload relays are not ready (LED "OFF") if there is no control supply voltage or if the function test was negative.
- Red "Ground fault" LED: A continuous red light signals a ground fault.
- Red "Thermistor" LED: A continuous red light signals a temperature-dependent trip.
- Red "Overload" LED: A continuous red light signals an inverse-time delayed trip; a flickering red light signals an imminent inverse-time delayed trip (overload warning).

### Auxiliary contacts

The 3RB22/3RB23 solid-state overload relays have two outputs, each with one NO contact and one NC contact. Their basic assignment/function may be influenced by function expansion modules.

The 3RB22 and 3RB23 differ with respect to the tripping characteristics of their auxiliary contacts – monostable or bistable:

The monostable 3RB22 solid-state overload relays will enter the "tripped" state if the control supply voltage fails (> 200 ms), and return to the original state they were in before the control supply voltage failed when the voltage returns. These devices are therefore especially suited for plants in which the control voltage is not strictly monitored.

The bistable 3RB23 overload relays do not change their "tripped" or "not tripped" status if the control voltage fails. The auxiliary contacts only switch over in the event of an overload and if the supply voltage is present. These devices are therefore especially suited for plants in which the control voltage is monitored separately.

### Response if the control supply voltage fails

If the control supply voltage fails for more than 0.2 s, the output relays respond differently depending on the version: Monostable or bistable.

# 3RB2 Solid-State Overload Relays

3RB22, 3RB23 for high-feature applications

| Response of the output relays in the event of                  | Monostable 3RB22  | Bistable 3RB23  |
|--|---|---|
| Failure of the control supply voltage                          | The device trips  | No change of the switching status of the auxiliary contacts   |
| Return of the control supply voltage without previous tripping | The device resets   | No change of the switching status of the auxiliary contacts   |
| Return of the control supply voltage after previous tripping   | The device remains tripped<br>Reset: <ul style="list-style-type: none"> <li>• For overload tripping, after 3 minutes</li> <li>• For thermistor tripping, after the temperature has fallen 5 K below the response temperature</li> <li>• For ground-fault tripping, immediately</li> </ul> | The device remains tripped<br>Reset: <ul style="list-style-type: none"> <li>• For overload tripping, after 3 minutes</li> <li>• For thermistor tripping, after the temperature has fallen 5 K below the response temperature</li> <li>• For ground-fault tripping, immediately</li> </ul> |

Monostable and bistable responses of the output relays

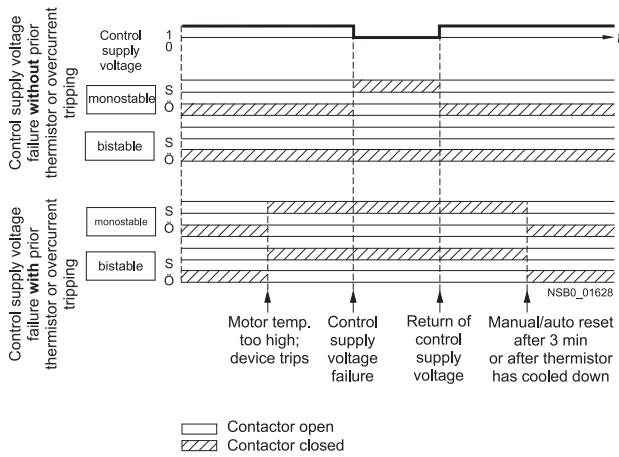

# 3RB2 Solid-State Overload Relays

3RB22, 3RB23 for standard applications



## Technical specifications

The following technical information is intended to provide an initial overview of the various types of device and functions.

Detailed information, see

- Reference Manual "Protection Equipment – 3RU1, 3RB2 Overload Relays", <http://support.automation.siemens.com/WWW/view/en/35681297>

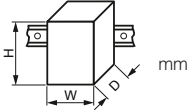
- or specific information on a particular article number via the product data sheet, <http://support.automation.siemens.com/WWW/view/en/20357046/133200>

| Type – Overload relay: evaluation modules   |   | 3RB2283-4A.1  | 3RB2383-4A.1 |
|---|---|---|--------------|
| Size contactor  |   | S00 ... S10/S12   |              |
| Dimensions of evaluation modules (W x H x D)  |  | 45 x 111 x 95 mm  |              |
| <b>General data</b>   |   |   |              |
| <b>Trips in the event of</b>  |   | Overload, phase failure and phase unbalance (> 40 % according to NEMA), + ground fault (with corresponding function expansion module) and activation of the thermistor motor protection (with closed PTC sensor circuit)                                |              |
| <b>Trip class</b> acc. to IEC 60947-4-1   | CLASS   | 5, 10, 20 and 30 adjustable   |              |
| <b>Phase failure sensitivity</b>  |   | Yes   |              |
| <b>Overload warning</b>   |   | Yes, from $1.125 \times I_e$ for symmetrical loads and from $0.85 \times I_e$ for unsymmetrical loads   |              |
| <b>Reset and recovery</b>   |   | Manual, automatic and remote RESET  |              |
| • Reset options after tripping  |   |   |              |
| • Recovery time   |   |   |              |
| - For automatic RESET   | min.  | - for tripping due to overcurrent: 3 (stored permanently)<br>- for tripping by thermistor: time until the motor temperature has fallen 5 K below the response temperature   |              |
| - For manual RESET  | min.  | - for tripping due to a ground fault: no automatic RESET<br>- for tripping due to overcurrent: 3 (stored permanently)<br>- for tripping by thermistor: time until the motor temperature has fallen 5 K below the response temperature                   |              |
| - For remote RESET  | min.  | - for tripping due to a ground fault: Immediately<br>- for tripping due to overcurrent: 3 (stored permanently)<br>- for tripping by thermistor: time until the motor temperature has fallen 5 K below the response temperature                          |              |
| - For remote RESET  | min.  | - for tripping due to a ground fault: Immediately   |              |
| <b>Features</b>   |   |   |              |
| • Display of operating state on device  |   | Yes, with four LEDs:<br>- green LED "Ready"<br>- red LED "Ground Fault"<br>- red LED "Thermistor"<br>- red LED "Overload"   |              |
| • TEST function   |   | Yes, test of LEDs, electronics, auxiliary contacts and wiring of control circuit by pressing the button TEST/RESET / self-monitoring  |              |
| • RESET button  |   | Yes, with the TEST/RESET button   |              |
| • STOP button   |   | No  |              |
| <b>Protection and operation of explosion-proof motors</b>                                     |   |   |              |
| EC type test certificate number according to directive 94/9/EC (ATEX)                         |   | PTB 05 ATEX 3022  II (2) GD, see <a href="http://support.automation.siemens.com/WWW/view/en/23115758">http://support.automation.siemens.com/WWW/view/en/23115758</a> | --           |
| <b>Ambient temperatures</b>   |   |   |              |
| • Storage/transport   | °C  | -40 ... +80   |              |
| • Operation   | °C  | -25 ... +60   |              |
| • Temperature compensation  | °C  | +60   |              |
| • Permissible rated current   |   |   |              |
| - Temperature inside control cabinet 60 °C  | %   | 100   |              |
| - Temperature inside control cabinet 70 °C  | %   | On request  |              |
| <b>Degree of protection</b> acc. to IEC 60529   |   | IP20: Current measuring modules in sizes S6 and S10/S12 with busbar connection in conjunction with cover.   |              |
| <b>Touch protection</b> acc. to IEC 61140   |   | Finger-safe: Current measuring modules in sizes S6 and S10/S12 with busbar connection in conjunction with cover.  |              |
| <b>Shock resistance with sine</b> acc. to IEC 60068-2-27                                      |   | g/ms  | 15/11        |
| <b>Electromagnetic compatibility (EMC) – Interference immunity</b>                            |   |   |              |
| • Conductor-related interference  |   |   |              |
| - Burst acc. to IEC 61000-4-4 (corresponds to degree of severity 3)                           | kV  | 2 (power ports), 1 (signal port)  |              |
| - Surge acc. to IEC 61000-4-5 (corresponds to degree of severity 3)                           | kV  | 2 (line to earth), 1 (line to line)   |              |
| • Electrostatic discharge according to IEC 61000-4-2 (corresponds to degree of severity 3)    | kV  | 8 (air discharge), 6 (contact discharge)  |              |
| • Field-related interference according to IEC 61000-4-3 (corresponds to degree of severity 3) | V/m   | 10  |              |
| <b>Electromagnetic compatibility (EMC) – emitted interference</b>                             |   | Degree of severity A according to EN 55011 (CISPR 11) and EN 55022 (CISPR 22)   |              |



# 3RB2 Solid-State Overload Relays

3RB22, 3RB23 for standard applications

| Type – Overload relay of current measuring module                                  | 3RB29           | 3RB29  | 3RB29  | 3RB29  |
|--|-----------------|--|--|--|
| Size   | S00/S0          | S2/S3  | S6   | S10/S12  |
| Width  | 45 mm           | 55 mm  | 120 mm   | 145 mm   |
| <b>Main circuit</b>  |                 |  |  |  |
| Rated insulation voltage $U_i$ (pollution degree 3)                                | V               | 1000   | 1000   |  |
| Rated impulse withstand voltage $U_{imp}$  | kV              | 6  | 8  |  |
| Rated operational voltage $U_e$  | V               | 690  | 1000   |  |
| Type of current  |                 | No   |  |  |
| • Direct current   |                 | Yes, 50/60 Hz $\pm$ 5 % (other frequencies on request)                               |  |  |
| • Alternating current  |                 |  |  |  |
| Set current  | A               | 0.3 ... 3;<br>2.4 ... 25   | 10 ... 100   | 20 ... 200<br>63 ... 630   |
| Power loss per unit (max.)   | W               | 0.5  |  |  |
| Short-circuit protection   |                 | See Selection and Ordering Data  |  |  |
| • With fuse without contactor  |                 | See Technical Specifications (short-circuit protection with fuses for motor feeders) |  |  |
| • With fuse and contactor  |                 |  |  |  |
| Safe isolation between main and auxiliary conducting path according to IEC 60947-1 | V               | 690 <sup>1)</sup>  |  |  |
| <b>Connection for main circuit</b>   |                 |  |  |  |
| Electrical connection version  |                 | Screw terminals with box terminal  |  |  |
| <b>Screw terminal</b>  |                 |  |  |  |
| • Terminal screw   | --              |  | 4 mm Allen screw   | 5 mm Allen screw   |
| • Tightening torque  | --              |  | 10 ... 12  | 20 ... 22  |
| • Conductor cross-sections (min./max.),<br>1 or 2 conductors                       |                 |  |  |  |
| - Solid  | mm <sup>2</sup> | --   | --   | --   |
| - Finely stranded without end sleeve   | mm <sup>2</sup> | --   | With 3RT19 55-4G box terminal:<br>2 $\times$ (1 $\times$ max. 50, 1 $\times$ max. 70),<br>1 $\times$ (10 ... 70)   | 2 $\times$ (50 ... 185),<br>front clamping point only:<br>1 $\times$ (70 ... 240)                                      |
|  |                 |  | With 3RT19 56-4G box terminal:<br>2 $\times$ (1 $\times$ max. 95, 1 $\times$ max. 120),<br>1 $\times$ (10 ... 120)   | rear clamping point only:<br>1 $\times$ (120 ... 185)  |
| - Finely stranded with end sleeve  | mm <sup>2</sup> | --   | With 3RT19 55-4G box terminal:<br>2 $\times$ (1 $\times$ max. 50, 1 $\times$ max. 70),<br>1 $\times$ (10 ... 70)   | 2 $\times$ (50 ... 185),<br>front clamping point only:<br>1 $\times$ (70 ... 240)                                      |
|  |                 |  | With 3RT19 56-4G box terminal:<br>2 $\times$ (1 $\times$ max. 95, 1 $\times$ max. 120),<br>1 $\times$ (10 ... 120)   | rear clamping point only:<br>1 $\times$ (120 ... 185)  |
| - Stranded   | mm <sup>2</sup> | --   | With 3RT19 55-4G box terminal:<br>2 $\times$ (max. 70),<br>1 $\times$ (16 ... 70)  | 2 $\times$ (70 ... 240),<br>front clamping point only:<br>1 $\times$ (95 ... 300)                                      |
|  |                 |  | With 3RT19 56-4G box terminal:<br>2 $\times$ (max. 120),<br>1 $\times$ (16 ... 120)  | rear clamping point only:<br>1 $\times$ (120 ... 240)  |
| - AWG conductors, solid or stranded  | AWG             | --   | With 3RT19 55-4G box terminal:<br>2 $\times$ (max. 1/0),<br>1 $\times$ (6 ... 2/0)   | 2 $\times$ (2/0 ... 500 kcmil),<br>front clamping point only:<br>1 $\times$ (3/0 ... 600 kcmil)                        |
|  |                 |  | With 3RT19 56-4G box terminal:<br>2 $\times$ (max. 3/0),<br>1 $\times$ (6 ... 250 kcmil)   | rear clamping point only:<br>1 $\times$ (250 kcmil ... 500 kcmil)  |
| - Ribbon cable conductors<br>(number x width x circumference)                      | mm              | --   | With 3RT19 55-4G box terminal:<br>2 $\times$ (6 $\times$ 15.5 $\times$ 0.8),<br>1 $\times$ (3 $\times$ 9 $\times$ 0.8 ... 6 $\times$ 15.5 $\times$ 0.8)      | 2 $\times$ (20 $\times$ 24 $\times$ 0.5),<br>1 $\times$ (6 $\times$ 9 $\times$ 0.8 ...<br>20 $\times$ 24 $\times$ 0.5) |
|  |                 |  | With 3RT19 56-4G box terminal:<br>2 $\times$ (10 $\times$ 15.5 $\times$ 0.8),<br>1 $\times$ (3 $\times$ 9 $\times$ 0.8 ...<br>10 $\times$ 15.5 $\times$ 0.8) |  |
| <b>Busbar connections</b>  |                 |  |  |  |
| • Terminal screw   | Nm              | --   | M8 $\times$ 25   | M10 $\times$ 30  |
| • Tightening torque  |                 | --   | 10 ... 14  | 14 ... 24  |
| • Conductor cross-section (min./max.)  |                 |  |  |  |
| - Solid with cable lug   | mm <sup>2</sup> | --   | 16 ... 95 <sup>2)</sup>  | 50 ... 240 <sup>3)</sup>   |
| - Stranded with cable lug  | mm <sup>2</sup> | --   | 25 ... 120 <sup>2)</sup>   | 70 ... 240 <sup>3)</sup>   |
| - AWG connections, solid or stranded, with cable lug                               | AWG             | --   | 4 ... 250 kcmil  | 2/0 ... 500 kcmil  |
| - With connecting bar (max. width)   | mm              | --   | 15   | 25   |
| <b>Straight-through transformers</b>   |                 |  |  |  |
| • Diameter of opening  | mm              | 7.5  | 14   | 25   |
| • Conductor cross-section (max.)   |                 |  |  |  |
| - NYY  | mm <sup>2</sup> | 4)   | 4)   | 120  |
| - H07RN-F  | mm <sup>2</sup> | 4)   | 4)   | 70   |

1) For grounded networks, otherwise 600 V.

2) When connecting cable lugs according to DIN 46235, use the 3RT19 56-4EA1 terminal cover for conductor cross-sections from 95 mm<sup>2</sup> to ensure phase spacing.

3) When connecting cable lugs according to DIN 46234 for conductor cross-sections from 240 mm<sup>2</sup> as well as DIN 46235 for conductor cross-sections from 185 mm<sup>2</sup>, use the 3RT19 56-4EA1 terminal cover to ensure phase spacing.

4) On request.

# 3RB2 Solid-State Overload Relays

3RB22, 3RB23 for standard applications

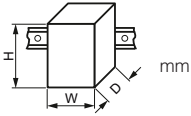

|  |   |   |                     |
|--|---|---|---------------------|
| <b>Type – Overload relay: evaluation modules</b>   |   | <b>3RB2283-4A.1</b>   | <b>3RB2383-4A.1</b> |
| Size contactor   |   | S00 ... S10/S12   |                     |
| Dimensions of evaluation modules (W x H x D)   |  | 45 x 111 x 95   |                     |
| <b>General data (continued)</b>  |   |   |                     |
| <b>Resistance to extreme climates – air humidity</b>   | %   | 100   |                     |
| <b>Dimensions</b>  |   | "Dimensional drawings", see<br><ul style="list-style-type: none"> <li>Reference Manual "Protection Equipment – 3RU1, 3RB2 Overload Relays", <a href="http://support.automation.siemens.com/WW/view/en/35681297">http://support.automation.siemens.com/WW/view/en/35681297</a></li> <li>Product data sheet, <a href="http://support.automation.siemens.com/WW/view/en/20357046/133200">http://support.automation.siemens.com/WW/view/en/20357046/133200</a></li> </ul> |                     |
| <b>Installation altitude above sea level</b>   | m   | Up to 2 000   |                     |
| <b>Mounting position</b>   |   | Any   |                     |
| <b>Type of mounting</b>  |   | Stand-alone installation  |                     |
| <ul style="list-style-type: none"> <li>Evaluation modules</li> <li>Current measuring module</li> </ul> | Size  | S00 to S3: Stand-alone installation, S6 and S10/S12: stand-alone installation or mounting onto contactors   |                     |

|  |    |   |  |
|--|----|---|--|
| <b>Type – Overload relay: evaluation modules</b>   |    | <b>3RB2283-4A.1, 3RB2383-4A.1</b>   |  |
| Size contactor   |    | S00 ... S10/S12   |  |
| <b>Auxiliary circuit</b>   |    |   |  |
| <b>Number of NO contacts</b>   |    | 2   |  |
| <b>Number of NC contacts</b>   |    | 2   |  |
| <b>Number of CO contacts</b>   |    | --  |  |
| <b>Auxiliary contacts – assignment</b>   |    | <ul style="list-style-type: none"> <li>Alternative 1 <ul style="list-style-type: none"> <li>- 1 NO for the signal "tripped by overload and/or thermistor"</li> <li>- 1 NC for disconnecting the contactor</li> <li>- 1 NO for the signal "tripped by ground fault"</li> <li>- 1 NC for disconnecting the contactor</li> </ul> </li> <li>or<sup>1)</sup></li> <li>Alternative 2 <ul style="list-style-type: none"> <li>- 1 NO for the signal "tripped by overload and/or thermistor and/or ground fault"</li> <li>- 1 NC for disconnecting the contactor</li> <li>- 1 NO for overload warning</li> <li>- 1 NC for disconnecting the contactor</li> </ul> </li> </ul> |  |
| <b>Rated insulation voltage <math>U_i</math></b> (pollution degree 3)  | V  | 300   |  |
| <b>Rated impulse withstand voltage <math>U_{imp}</math></b>  | kV | 4   |  |
| <b>Auxiliary contacts – contact rating</b>   |    |   |  |
| <ul style="list-style-type: none"> <li>NC contact with alternating current AC-14/AC-15, rated operational current <math>I_e</math> at <math>U_e</math> <ul style="list-style-type: none"> <li>- 24 V</li> <li>- 120 V</li> <li>- 125 V</li> <li>- 250 V</li> </ul> </li> <li>NO contact with alternating current AC-14/AC-15, rated operational current <math>I_e</math> at <math>U_e</math> <ul style="list-style-type: none"> <li>- 24 V</li> <li>- 120 V</li> <li>- 125 V</li> <li>- 250 V</li> </ul> </li> <li>NC contact, NO contact with direct current DC-13, rated operational current <math>I_e</math> at <math>U_e</math> <ul style="list-style-type: none"> <li>- 24 V</li> <li>- 60 V</li> <li>- 110 V</li> <li>- 125 V</li> <li>- 250 V</li> </ul> </li> <li>Conventional thermal current <math>I_{th}</math></li> <li>Contact reliability (suitability for PLC control; 17 V, 5 mA)</li> </ul> | A  |   | 6<br>6<br>6<br>3<br><br>6<br>6<br>6<br>3<br><br>2<br>0.55<br>0.3<br>0.3<br>0.2<br><br>5<br>Yes |
| <b>Short-circuit protection</b>  |    |   |  |
| <ul style="list-style-type: none"> <li>With fuse, operational class gG</li> <li>With miniature circuit breaker, C characteristic</li> </ul>  | A  |   | 6<br>1.6   |
| <b>Protective separation between auxiliary current paths</b> acc. to IEC 60947-1   | V  | 300   |  |
| <b>CSA, UL, UR rated data</b>  |    |   |  |
| <b>Auxiliary circuit – switching capacity</b>  |    | B300, R300  |  |

<sup>1)</sup> The assignment of auxiliary contacts may be influenced by function expansion modules.

# 3RB2 Solid-State Overload Relays

3RB22, 3RB23 for standard applications

|  |                 |  |
|--|-----------------|--|
| <b>Type – Overload relay: evaluation modules</b>   |                 | <b>3RB2283-4A.1, 3RB2383-4A.1</b>  |
| Size contactor   |                 | S00 ... S10/S12  |
| <b>Control circuit</b>   |                 |  |
| <b>Rated insulation voltage <math>U_i</math></b><br>(pollution degree 3)                                   | V               | 300  |
| <b>Rated impulse withstand voltage <math>U_{imp}</math></b>  | kV              | 4  |
| <b>Rated control supply voltage <math>U_s</math></b>   |                 |  |
| • 50/60 Hz AC  | V               | 24 ... 240   |
| • DC   | V               | 24 ... 240   |
| <b>Operating range</b>   |                 |  |
| • 50/60 Hz AC  |                 | $0.85 \times U_{s \min} \leq U_s \leq 1.1 \times U_{s \max}$   |
| • DC   |                 | $0.85 \times U_{s \min} \leq U_s \leq 1.1 \times U_{s \max}$   |
| <b>Rated power</b>   |                 |  |
| • 50/60 Hz AC  | W               | 0.5  |
| • DC   | W               | 0.5  |
| <b>Mains buffering time</b>  | ms              | 200  |
| <b>Sensor circuit</b>  |                 |  |
| <b>Thermistor motor protection (PTC thermistor sensor)</b>   |                 |  |
| • Summation cold resistance  | k $\Omega$      | $\leq 1.5$   |
| • Response value   | k $\Omega$      | 3.4 ... 3.8  |
| • Return value   | k $\Omega$      | 1.5 ... 1.65   |
| <b>Ground-fault detection</b>  |                 |  |
| The information refers to sinusoidal residual currents at 50/60 Hz.  |                 |  |
| • Tripping value $I_A^{(1)}$   |                 |  |
| - For $0.3 \times I_e < I_{motor} < 2.0 \times I_e$  |                 | $> 0.3 \times I_e$   |
| - For $2.0 \times I_e < I_{motor} < 8.0 \times I_e$  |                 | $> 0.15 \times I_{motor}$  |
| • Response time $t_{trip}$   | ms              | 500 ... 1 000  |
| <b>Analog output<sup>1)2)</sup></b>  |                 |  |
| <b>Rated values</b>  |                 |  |
| • Output signal  | mA              | 4 ... 20   |
| • Measuring range  |                 | $0 \dots 1.25 \times I_e$<br>4 mA corresponds to $0 \times I_e$<br>16.8 mA corresponds to $1.0 \times I_e$<br>20 mA corresponds to $1.25 \times I_e$ |
| • Load, max.   | $\Omega$        | 100  |
| <b>Conductor cross-sections for the auxiliary, control and sensor circuit as well as the analog output</b> |                 |  |
| <b>Connection type</b>   |                 |  <b>Screw terminals</b>   |
| <b>Terminal screw</b>  |                 | M3, Pozidriv size 2  |
| <b>Operating devices</b>   | mm              | 3.0 x 0.5  |
| <b>Prescribed tightening torque</b>  | Nm              | 0.8 ... 1.2  |
| <b>Conductor cross-sections (min./max.),</b><br>1 or 2 conductors can be connected                         |                 |  |
| • Solid or stranded  | mm <sup>2</sup> | $1 \times (0.5 \dots 4)^3, 2 \times (0.5 \dots 2.5)^3$   |
| • Finely stranded without end sleeve   | mm <sup>2</sup> | --   |
| • Finely stranded with end sleeve (DIN 46228-1)  | mm <sup>2</sup> | $1 \times (0.5 \dots 2.5)^3, 2 \times (0.5 \dots 1.5)^3$   |
| • AWG cables, solid or stranded  | AWG             | $2 \times (20 \dots 14)$   |
| <b>Connection type</b>   |                 |  <b>Spring-type terminals</b>                                     |
| <b>Operating devices</b>   | mm              | 3.0 x 0.5  |
| <b>Conductor cross-sections (min./max.),</b><br>1 or 2 conductors can be connected                         |                 |  |
| • Solid or stranded  | mm <sup>2</sup> | $2 \times (0.25 \dots 1.5)$  |
| • Finely stranded without end sleeve   | mm <sup>2</sup> | --   |
| • Finely stranded with end sleeve (DIN 46228-1)  | mm <sup>2</sup> | $2 \times (0.25 \dots 1.5)$  |
| • AWG cables, solid or stranded  | AWG             | $2 \times (24 \dots 16)$   |

1) For the 3RB22 and 3RB23 overload relays in combination with a corresponding function expansion module.

2) Analog input modules, e.g. SM 331, must be configured for 4-wire measuring transducers. In this case the analog input module must not supply current to the analog output of the 3RB22 and 3RB23 relay.

3) If two different conductor cross-sections are connected to one clamping point, both cross-sections must be in the range specified.

# 3RB2 Solid-State Overload Relays

3RB22, 3RB23 for standard applications

## Short-circuit protection with fuses for motor feeders

For short-circuit currents up to 50 kA at 400 to 690 V

| Overload relays     | Contactor            | CLASS  |       |       |       |       |       |       |       |       | 690 V                              |                   |    |
|---------------------|----------------------|--|-------|-------|-------|-------|-------|-------|-------|-------|------------------------------------|-------------------|----|
|                     |                      | 5 and 10                                     |       |       | 20    |       |       | 30    |       |       | Fuse links <sup>1)</sup>           | Type 3NA          |    |
| Setting range       | Type                 | Rated operational current $I_e$ AC-3 in A at |       |       |       |       |       |       |       |       | Type of coordination <sup>2)</sup> |                   |    |
|                     |                      | 400 V  | 500 V | 690 V | 400 V | 500 V | 690 V | 400 V | 500 V | 690 V | 1                                  | 2                 |    |
| <b>Size S00/S0</b>  |                      |  |       |       |       |       |       |       |       |       |                                    |                   |    |
| 0.3 ... 3 A         | 3RT20 15             | 3  | 3     | 3     | 3     | 3     | 3     | 3     | 3     | 3     | 3                                  | 35                | 20 |
|                     | 3RT20 16             | 3  | 3     | 3     | 3     | 3     | 3     | 3     | 3     | 3     | 3                                  | 35                | 20 |
| 2.4 ... 25 A        | 3RT20 15             | 7  | 5     | 4     | 7     | 5     | 4     | 7     | 5     | 4     | 35                                 | 20                |    |
|                     | 3RT20 16             | 9  | 6.5   | 5.2   | 9     | 6.5   | 5.2   | 9     | 6.5   | 5.2   | 35                                 | 20                |    |
|                     | 3RT20 17             | 12   | 9     | 6.3   | 10    | 9     | 6.3   | 9     | 9     | 6.3   | 35                                 | 20                |    |
|                     | 3RT20 23             | 9  | 6.5   | 5.2   | 9     | 6.5   | 5.2   | --    | --    | --    | 63                                 | 25                |    |
|                     | 3RT20 24             | 12   | 12    | 9     | 12    | 12    | 9     | 12    | 12    | 9     | 63                                 | 25                |    |
|                     | 3RT20 25             | 17   | 17    | 13    | 16    | 16    | 13    | 14    | 14    | 13    | 63                                 | 25                |    |
|                     | 3RT20 26             | 25   | 18    | 13    | 16    | 16    | 13    | 14    | 14    | 13    | 100                                | 35                |    |
|                     | <b>Size S2/S3</b>    |  |       |       |       |       |       |       |       |       |                                    |                   |    |
| On request          | 3RT20 35             | On request                                   |       |       |       |       |       |       |       |       |                                    |                   |    |
|                     | 3RT20 36             | On request                                   |       |       |       |       |       |       |       |       |                                    |                   |    |
|                     | 3RT10 44             | On request                                   |       |       |       |       |       |       |       |       |                                    |                   |    |
|                     | 3RT10 45             | On request                                   |       |       |       |       |       |       |       |       |                                    |                   |    |
|                     | 3RT10 46             | On request                                   |       |       |       |       |       |       |       |       |                                    |                   |    |
|                     | 3RT10 54<br>3RT10 55 | On request                                   |       |       |       |       |       |       |       |       |                                    |                   |    |
| <b>Size S6</b>      |                      |  |       |       |       |       |       |       |       |       |                                    |                   |    |
| 20 ... 200 A        | 3RT10 54             | 115  | 115   | 115   | 81.7  | 81.7  | 81.7  | 69    | 69    | 69    | 355                                | 315               |    |
|                     | 3RT10 55             | 150  | 150   | 150   | 107   | 107   | 107   | 90    | 90    | 90    | 355                                | 315               |    |
|                     | 3RT10 56             | 185  | 185   | 170   | 131   | 131   | 131   | 111   | 111   | 111   | 355                                | 315               |    |
| <b>Size S10/S12</b> |                      |  |       |       |       |       |       |       |       |       |                                    |                   |    |
| 160 ... 630 A       | 3RT10 64             | 225  | 225   | 225   | 160   | 160   | 160   | 135   | 135   | 135   | 500                                | 400               |    |
|                     | 3RT10 65             | 265  | 265   | 265   | 188   | 188   | 188   | 159   | 159   | 159   | 500                                | 400               |    |
|                     | 3RT10 66             | 300  | 300   | 280   | 213   | 213   | 213   | 180   | 180   | 180   | 500                                | 400               |    |
|                     | 3RT10 75             | 400  | 400   | 400   | 284   | 284   | 284   | 240   | 240   | 240   | 630                                | 400               |    |
|                     | 3RT10 76             | 500  | 500   | 450   | 355   | 355   | 355   | 300   | 300   | 300   | 630                                | 500               |    |
|                     | 3RT12 64             | 225  | 225   | 225   | 225   | 225   | 225   | 173   | 173   | 173   | 500                                | 500               |    |
|                     | 3RT12 65             | 265  | 265   | 265   | 265   | 265   | 265   | 204   | 204   | 204   | 500                                | 500               |    |
|                     | 3RT12 66             | 300  | 300   | 300   | 300   | 300   | 300   | 231   | 231   | 231   | 500                                | 500               |    |
|                     | 3RT12 75             | 400  | 400   | 400   | 400   | 400   | 400   | 316   | 316   | 316   | 800                                | 800               |    |
|                     | 3RT12 76             | 500  | 500   | 500   | 500   | 500   | 500   | 385   | 385   | 385   | 800                                | 800               |    |
|                     | 3TF68 <sup>3)</sup>  | 630  | 630   | 630   | 440   | 440   | 440   | 376   | 376   | 376   | 800                                | 500 <sup>4)</sup> |    |
|                     | 3TF69 <sup>3)</sup>  | 630  | 630   | 630   | 572   | 572   | 572   | 500   | 500   | 500   | 800                                | 630 <sup>4)</sup> |    |

1) Please observe operational voltage.

2) Coordination and short-circuit equipment according to EN 60947-4-1:

**Type of coordination 1:** the contactor or starter must not endanger persons or the installation in the event of a short-circuit. They do not need to be suitable for further operation without repair and the renewal of parts.

**Type of coordination 2:** the contactor or starter must not endanger persons or the installation in the event of a short-circuit. They must be suitable for further operation. There is a risk of contact welding.

3) Contactor cannot be mounted.

4) Please ensure that the maximum AC-3 operational current has sufficient safety clearance from the rated current of the fuses.

# 3RB2 Solid-State Overload Relays

3RB22, 3RB23 for standard applications

## Characteristic curves

The tripping characteristics show the relationship between the tripping time and tripping current as multiples of the set current  $I_e$  and are given for symmetrical three-pole and two-pole loads from the cold state.

The smallest current used for tripping is called the minimum tripping current. According to IEC 60947-4-1, this current must be within specified limits. The limits of the minimum tripping current for the 3RB22/3RB23 solid-state overload relays for symmetrical three-pole loads are between 105 % and 120 % of the set current.

The tripping characteristic starts with the minimum tripping current and continues with higher tripping currents based on the characteristics of the so-called trip classes (CLASS 10, CLASS 20 etc.). The trip classes describe time intervals within which the overload relays have to trip with 7.2 times the set current  $I_e$  from the cold state for symmetrical three-pole loads.

The tripping times according to IEC 60947-4-1, tolerance band E, are as follows for:

| Trip class | Tripping time |
|------------|---------------|
| CLASS 5    | 3 ... 5 s     |
| CLASS 10   | 5 ... 10 s    |
| CLASS 20   | 10 ... 20 s   |
| CLASS 30   | 20 ... 30 s   |

The tripping characteristic for a three-pole overload relay from the cold state (see illustration 1) only apply if all three phases are simultaneously loaded with the same current. In the event of a phase failure or a current unbalance of more than 40 %, the 3RB22/3RB23 solid-state overload relays switch off the contactor more quickly in order to minimize heating of the load in accordance with the tripping characteristic for two-pole loads from the cold state (see illustration 2).

Compared with a cold load, a load at operating temperature obviously has a lower temperature reserve. The tripping time of the 3RB22/3RB23 solid-state overload relays are reduced therefore to about 30 % when loaded with the set current  $I_e$  for an extended period.

Tripping characteristics for 3-pole loads

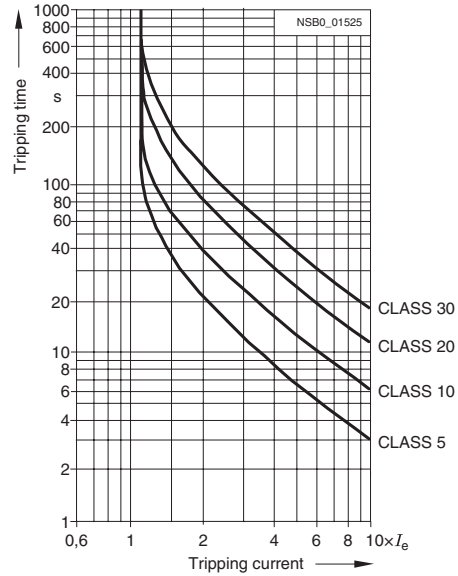

Illustration 1

Tripping characteristics for 2-pole loads

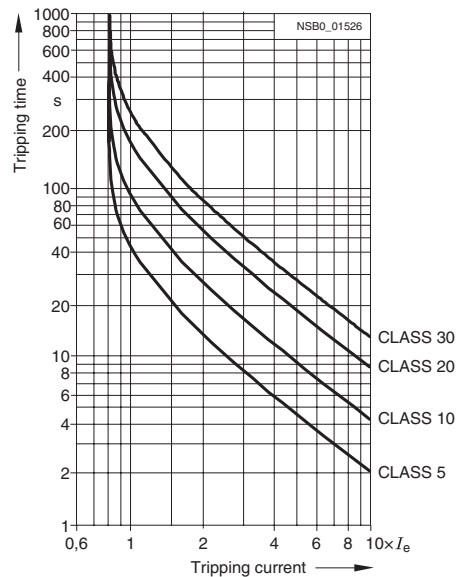

Illustration 2

The above illustrations are schematic representations of characteristic curves. The characteristic curves of the individual 3RB22/3RB23 solid-state overload relays can be requested from Technical Assistance at the following e-mail address:

[Technical-assistance@siemens.com](mailto:Technical-assistance@siemens.com)

# 3RB2 Solid-State Overload Relays

3RB22, 3RB23 for standard applications

## Dimensional drawings

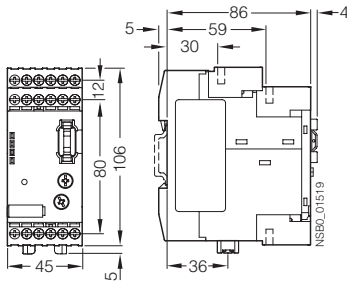

3RB22 83-4, 3RB23 83-4 evaluation module

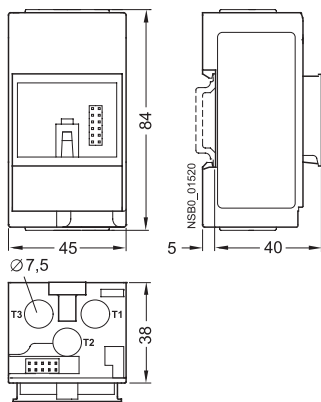

3RB29 06-2BG1, 3RB29 06-2DG1 current measuring module

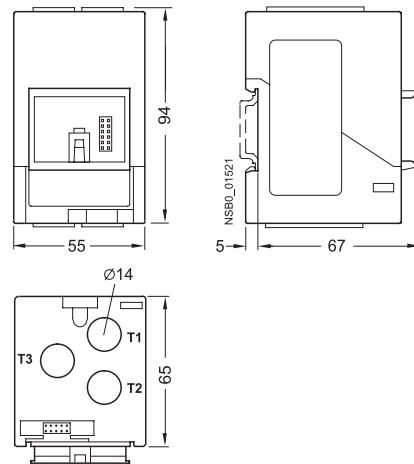

3RB29 06-2JG1 current measuring module

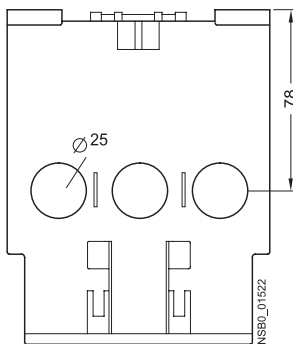
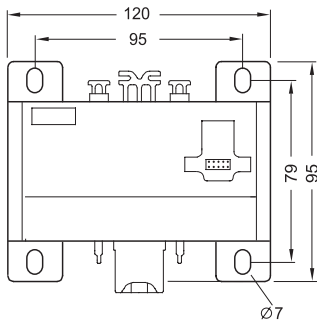

3RB29 56-2TG2 current measuring module



# 3RB2 Solid-State Overload Relays

3RB22, 3RB23 for standard applications

3  
OVERLOAD  
RELAYS

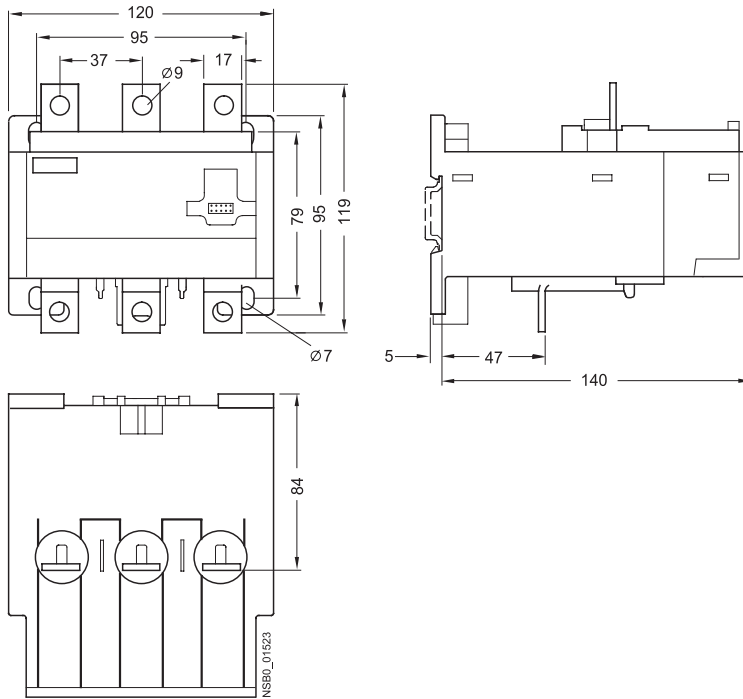

3RB29 56-2TH2 current measuring module

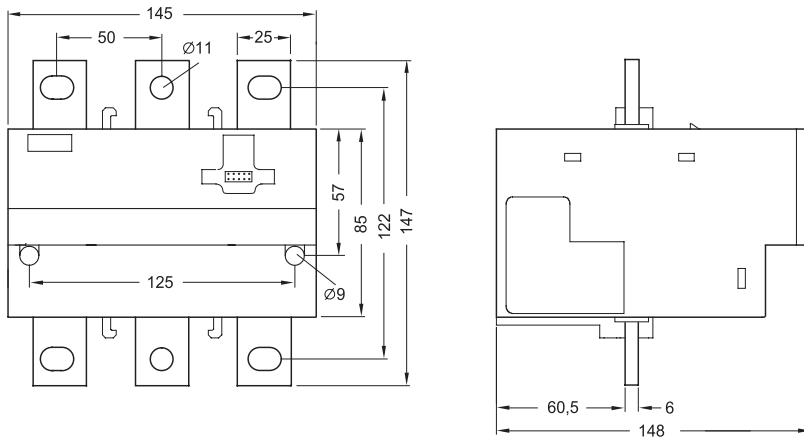

3RB29 66-2WH2 current measuring module

# 3RB2 Solid-State Overload Relays

3RB22, 3RB23 for standard applications

## Schematics

### Protection of single-phase motors

(not in conjunction with internal ground-fault detection)

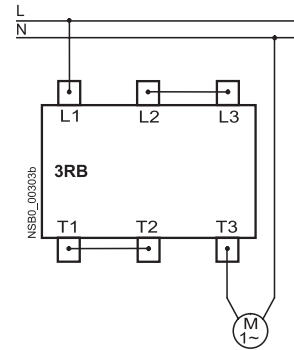
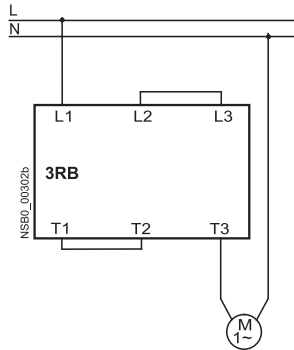

3RB29 06-2.G1, 3RB29 56-2TG2

3RB29 56-2TH2, 3RB29 66-2WH2

### Schematic representation of a possible application (3-phase)

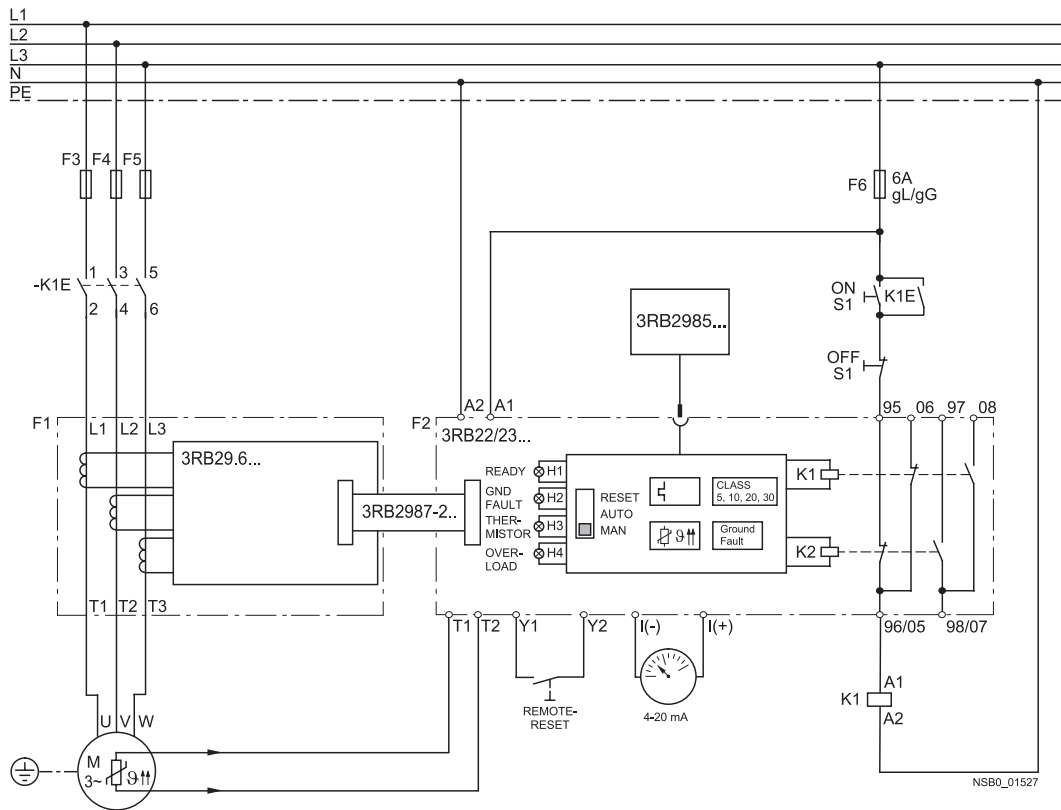

## 3RB2 Solid-State Overload Relays

## 3RB22, 3RB23 for standard applications

## Connections

| Evaluation module  | Function expansion module | Basic functions   | Inputs                             |                              |                            |
|--|---------------------------|---|------------------------------------|------------------------------|----------------------------|
|  |                           |   | A1/A2                              | T1/T2                        | Y1/Y2                      |
| 3RB22 83-4AA1<br>3RB22 83-4AC1<br>3RB23 83-4AA1<br>3RB23 83-4AC1 | None                      | Inverse-time delayed protection, temperature-dependent protection, electrical remote RESET, overload warning  | Power supply<br>24 ... 240 V AC/DC | Connection for<br>PTC sensor | Electrical<br>remote RESET |
|  | 3RB29 85-2CA1             | Inverse-time delayed protection, temperature-dependent protection, internal ground-fault detection, electrical remote RESET, overload warning                   | Power supply<br>24 ... 240 V AC/DC | Connection for<br>PTC sensor | Electrical<br>remote RESET |
|  | 3RB29 85-2CB1             | Inverse-time delayed protection, temperature-dependent protection, internal ground-fault detection, electrical remote RESET, ground fault signal                | Power supply<br>24 ... 240 V AC/DC | Connection for<br>PTC sensor | Electrical<br>remote RESET |
|  | 3RB29 85-2AA0             | Inverse-time delayed protection, temperature-dependent protection, electrical remote RESET, overload warning, analog output                                     | Power supply<br>24 ... 240 V AC/DC | Connection for<br>PTC sensor | Electrical<br>remote RESET |
|  | 3RB29 85-2AA1             | Inverse-time delayed protection, temperature-dependent protection, internal ground-fault detection, electrical remote RESET, overload warning, analog output    | Power supply<br>24 ... 240 V AC/DC | Connection for<br>PTC sensor | Electrical<br>remote RESET |
|  | 3RB29 85-2AB1             | Inverse-time delayed protection, temperature-dependent protection, internal ground-fault detection, electrical remote RESET, ground fault signal, analog output | Power supply<br>24 ... 240 V AC/DC | Connection for<br>PTC sensor | Electrical<br>remote RESET |

| Evaluation module  | Function expansion module | Outputs       |  |                  |  |                            |
|--|---------------------------|---------------|--|------------------|--|----------------------------|
|  |                           | I (-) / I (+) | 95/96 NC   | 97/98 NO         | 05/06 NC                                   | 07/08 NO                   |
| 3RB22 83-4AA1<br>3RB22 83-4AC1<br>3RB23 83-4AA1<br>3RB23 83-4AC1 | None                      | No            | Switching off the contactor (inverse-time delayed/temperature-dependent protection)                | Signal "tripped" | Overload warning                           | Overload warning           |
|  | 3RB29 85-2CA1             | No            | Switching off the contactor (inverse-time delayed/temperature-dependent protection + ground fault) | Signal "tripped" | Overload warning                           | Overload warning           |
|  | 3RB29 85-2CB1             | No            | Switching off the contactor (inverse-time delayed/temperature-dependent protection)                | Signal "tripped" | Switching off the contactor (ground fault) | Signal "ground fault trip" |
|  | 3RB29 85-2AA0             | Analog signal | Switching off the contactor (inverse-time delayed/temperature-dependent protection)                | Signal "tripped" | Overload warning                           | Overload warning           |
|  | 3RB29 85-2AA1             | Analog signal | Switching off the contactor (inverse-time delayed/temperature-dependent protection + ground fault) | Signal "tripped" | Overload warning                           | Overload warning           |
|  | 3RB29 85-2AB1             | Analog signal | Switching off the contactor (inverse-time delayed/temperature-dependent protection)                | Signal "tripped" | Switching off the contactor (ground fault) | Signal "ground fault trip" |